

WALL AND CEILING LUMINAIRES

Luminaires for Low-voltage bulbs MR16



Page 119



Page 130

Luminaires for Low-voltage bulbs QRB111



Page 119



Page 116



Page 122



Page 124



Page 128



Page 123



Page 120

Luminaires for High-voltage bulbs G9



Page 096



Page 108



Page 109

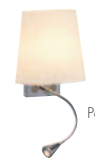

Page 175



Page 108



Page 109



Page 109



Page 107

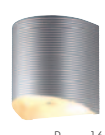

Page 160

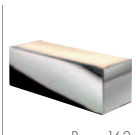

Page 162



Page 148



Page 149



Page 160



Page 120

Luminaires for High-voltage bulbs GU10



Page 119



Page 133



Page 110



Page 110



Page 143



Page 141



Page 144



Page 130



Page 130



Page 130



Page 129



Page 140

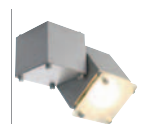

Page 142



Page 144

	 Page 140	 Page 142	 Page 123	 Page 132	 Page 110		
	 Page 113	 Page 158	 Page 110	 Page 133	 Page 139	 Page 141	 Page 143
Luminaires for High-voltage bulbs ES111	 Page 116	 Page 119	 Page 135	 Page 135	 Page 126	 Page 120	 Page 120
	 Page 130	 Page 139	 Page 139	 Page 139	 Page 136	 Page 136	
Luminaires for High-voltage bulbs R7s	 Page 173	 Page 164	 Page 165	 Page 159	 Page 161	 Page 115	 Page 114
Luminaires for High-voltage line bulbs S14d	 Page 102	 Page 102	 Page 163				
Luminaires for Energy-saving bulbs	 Page 096	 Page 130	 Page 098	 Page 100	 Page 098	 Page 113	 Page 104
	 Page 105	 Page 105	 Page 106	 Page 106	 Page 133	 Page 097	 Page 188
	 Page 113	 Page 100	 Page 100	 Page 098	 Page 099	 Page 099	 Page 193
	 Page 194	 Page 098	 Page 096	 Page 193			
	 Page 193	 Page 194	 Page 194	 Page 194	 Page 193	 Page 188	 Page 188



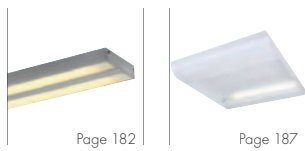
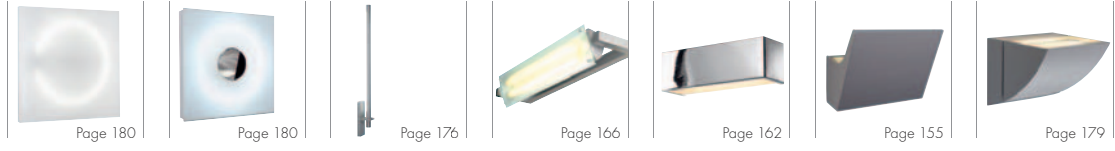

Ceiling luminaires with grid reflector



Luminaires for CDM-TC/CDM-TS



LED luminaires







ORION PLATE

230~



Socket/Bulb:
G9/G9 (excl.)
40W max.
or
G9/EnergySaver (excl.)

Material:
Steel/glass

Dimensions:
Product-Ø/H: 17,5/15 cm
Plate-Ø: 17,5 cm
Glass-Ø/H: 12,5/10 cm

Accessory/Included parts:
Canopy (incl.)

Recommended bulb:
33W EnergySaver ± 40W
2700K, 460lm, EEK=C
519451



Versions:
Glass white
silver grey
chrome

Art. No.:
134201
134261

Recommended bulb:
9W, 2700K, 405lm, EEK=A
508940



COMMO CL-1

230~



Series: page 079



Socket/Bulb:
GX53/GX53 EnergySaver (excl.)
13W max.

Material:
Steel/glass

Dimensions:
Ø/H: 10/15 cm

Versions:
Glass satined
chrome

Art. No.:
134310

Recommended bulb:
9W, 2700K, 260lm
508860





SUN CEILING Design by CDC

230~



Series: page 074



Socket/Bulb:
E27/AGL (excl.)
75W max.
or
E27/EnergySaver (excl.)
up to max. Ø/L: 7/12 cm

Material:
Aluminium/glass

Dimensions:
Ø/H: 19/19,5 cm
Canopy-Ø/H: 11/2 cm

Accessory/Included parts:
Canopy (incl.)

Note:
Mouth-blown glass shade.
Every lamp is an unique.

Versions:
alu/white

Art. No.:
134221

Recommended bulb:
15W, 2700K, 800lm, EEK=A
508960



BIG SUN CEILING Design by CDC

230~



Series: page 074



Socket/Bulb:
E27/AGL (excl.)
75W max.
or
E27/EnergySaver (excl.)
up to max. Ø/L: 7/17,5 cm

Material:
Aluminium/glass

Dimensions:
Ø/H: 30/30 cm
Canopy-Ø/H: 11/2 cm

Accessory/Included parts:
Canopy (incl.)

Note:
Mouth-blown glass shade.
Every lamp is an unique.

Versions:
alu/white

Art. No.:
134301

Recommended bulb:
20W, 2700K, 1150lm, EEK=A
508830





WL 103 E14

230-



IP23

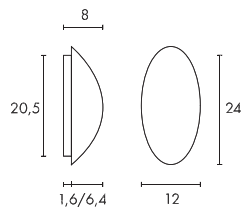

Socket/Bulb:
E14/AGL (excl.)
40W max.
or
E14/EnergySaver (excl.)
up to max. Ø/L: 4/13 cm

Material:
Steel/glass

Versions:
Glass satined
white

Art. No.:
155240

Recommended bulb:
11W, 2700K, 530lm, EEK=A
508810



WL 104 E27

230-



IP23

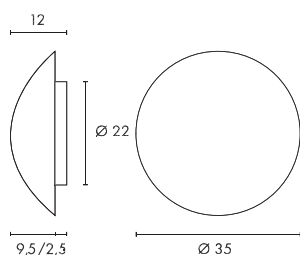
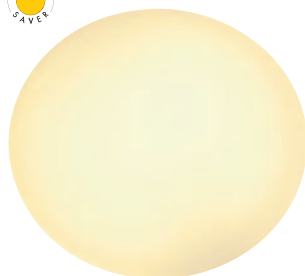

Socket/Bulb:
E27/AGL (excl.)
60W max.
or
E27/EnergySaver (excl.)
up to max. L: 17 cm

Material:
Steel/glass

Versions:
Glass satined
white

Art. No.:
155250

Recommended bulb:
15W, 2700K, 900lm, EEK=A
508415



VESUVIO Design by CDC

230-



IP23



Socket/Bulb:
E14/AGL candle shape (excl.)
3x 40W max.
or
E14/EnergySaver (excl.)
up to max. Ø/L: 4,8/9,6 cm

Material:
Steel/glass

Dimensions:
Ø/H: 31,5/9,5 cm

Versions:
Glass white
chrome

Art. No.:
149352

Recommended bulb:
11W, 2700K, 575lm, EEK=A
508630



LAMOO Design by CDC

230-



IP23



Socket/Bulb:
E27/AGL (excl.)
100W max.
or
E27/EnergySaver (excl.)
up to max. Ø/L: 5,2/14,8 cm

Material:
Steel/glass

Dimensions:
Ø/H: 45/20 cm
Glass-Ø/H: 24/15 cm

Versions:
Glass satined
metal brushed ▼

Art. No.:
157165

Recommended bulb:
23W, 2700K, 1350lm, EEK=A
508970



MELAN

 230~     

Socket/Bulb:
E27/AGL (excl.)
60W max.
or
E27/EnergySaver (excl.)
up to max. Ø/L: 7/16 cm

Material:
Aluminium/glass

Dimensions:
Ø/H: 32/10 cm

Versions:
Glass satined
alu brushed

Art. No.:
155236

Recommended bulb:
15W, 2700K, 800lm, EEK=A
508960

CORONA CL-1

 230~    IP21 

Socket/Bulb:
E27/AGL (excl.)
60W max.
or
E27/EnergySaver (excl.)
up to max. L: 13,7 cm

Material:
Aluminium/steel/glass

Dimensions:
Ø/H: 30/10 cm

Versions:
Glass satined
chrome

Art. No.:
155272

Recommended bulb:
23W, 2700K, 1350lm, EEK=A
508770





GLASSA SQUARE TC-DE

230~

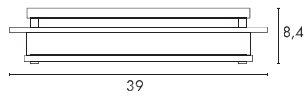

Socket/Bulb:
G24q-3/
TC-DE EnergySaver (excl.)
2x 26W

Material:
Glass/steel

Dimensions:
L/W/H: 39/39/8,4 cm

Accessory/Included parts:
Electronic ballast (incl.)

Versions:
Glass satined

Art. No.:
155190

Recommended bulb:
26W, 3000K, 1800lm, EEK=B
508222



GLASSA ROUND TC-DE

230~



Socket/Bulb:
G24q-3/
TC-DE EnergySaver (excl.)
2x 26W

Material:
Glass/steel

Dimensions:
Ø/H: 40/8,5 cm

Accessory/Included parts:
Electronic ballast (incl.)

Versions:
Glass satined

Art. No.:
155195

Recommended bulb:
26W, 3000K, 1800lm, EEK=B
508222



GLASSA SQUARE E27

230~

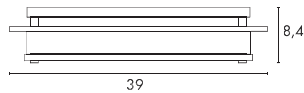

Socket/Bulb:
E27/AGL (excl.)
2x 60W max.
or
E27/EnergySaver (excl.)
up to max. L: 14,8 cm

Material:
Glass/steel

Dimensions:
L/W/H: 39/39/8,4 cm

Versions:
Glass satined

Art. No.:
155180

Recommended bulb:
23W, 2700K, 1350lm, FFK=A
508970



GLASSA ROUND E27

230~



Socket/Bulb:
E27/AGL (excl.)
2x 60W
or
E27/EnergySaver (excl.)
up to max. Ø/L: 4,8/13,6 cm

Material:
Glass/steel

Dimensions:
Ø/H: 40/8,5 cm

Versions:
Glass satined

Art. No.:
155185

Recommended bulb:
20W, 2700K, 1200lm, EEK=A
508760



DANAX

230~



Socket/Bulb:
E14/AGL candle shape (excl.)
2x 40W max.
or
E14/EnergySaver (excl.)
up to max. Ø/L: 4,8/9,6 cm

Material:
Steel/glass

Dimensions:
Ø/H: 31/11 cm

Versions:
Glass partial satined

Art. No.:
151644

Recommended bulb:
11W, 2700K, 575lm, EEK=A
508630







Z 211

230~



Socket/Bulb:
G23/TC-S EnergySaver (excl.)
2x 11W

Material:
Steel/glass

Dimensions:
W/H/D: 9/58/7,5 cm

Accessory/Included parts:
Low-loss ballast (incl.)

Versions:
metal brushed
Glass partial satined

Art. No.:
147455

Recommended bulb:
11W, 2700K, 900lm, EEK=A
508310



LINE Design by CDC

230~



Socket/Bulb:
S14d/line bulb (excl.)
35/60W

Material:
Plastic

Dimensions:
Socket-W/H/D: 4,7/10,2/3,8 cm

Recommended bulb:
35W, 2700K, 270lm, EEK=F
30 cm, matt
590150

Versions:
Armature for line bulb
chrome

Art. No.:
160702

Recommended bulb:
60W, 2700K, 420lm, EEK=G
50 cm, matt
590151



NIABI Design by CDC

230~



IP23

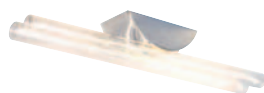

Socket/Bulb:
S14d/line bulb (excl.)
2x 35/60W

Material:
Aluminium

Dimensions:
L/W/H: 15,5/7,5/5 cm

Recommended bulb:
35W, 2700K, 270lm, EEK=F
30 cm, matt
590150

Versions:
Armature for line bulb
chrome

Art. No.:
157342

Recommended bulb:
60W, 2700K, 460lm, EEK=G
50 cm, clear
590152







CALMA IP44



230~

Socket/Bulb:
G23/TC-S EnergySaver (excl.)
11W

Versions:
chrome/white

Art. No.:
151442

Material:
Steel/brass
Shade acrylic

Recommended bulb:
11W, 2700K, 900lm, EEK=A
508310



Dimensions:
W/H/D: 6/39/9,5 cm
Shade-Ø/H: 6/24,5 cm

Accessory/Included parts:
Low-loss ballast (incl.)



DEVIN DOUBLE



230~

Socket/Bulb:
E14/EnergySaver (excl.)
2x 11W max.
up to max. Ø/L: 4/14 cm

Versions:
chrome/white

Art. No.:
151552

Material:
Steel/glass

Recommended bulb:
11W, 2700K, 530lm, EEK=A
508810



Dimensions:
Ø/H/D: 6,5/46,5/9,5 cm
Glass-Ø/H: 6,5/16 cm
Canopy-W/H/D: 4,5/14,5/2 cm



WL 105 E14



230~



IP44



Socket/Bulb:
E14/AGL candle shape (excl.)
40W max.
or
E14/EnergySaver (excl.)
up to max. Ø/L 3,6/11 cm

Versions:
chrome

Art. No.:
149482

Material:
Aluminium/steel/glass

Recommended bulb:
7W, 2700K, 285lm, EEK=A
508800



Dimensions:
W/H/D: 9,5/26/11 cm
Glass-Ø/H: 7/18,5 cm
Canopy-Ø/H: 9,5/2,5 cm

WL 106 E14



230~



IP44



Socket/Bulb:
E14/AGL candle shape (excl.)
2x 40W max.
or
E14/EnergySaver (excl.)
up to max. Ø/L 3,6/11 cm

Versions:
chrome

Art. No.:
149492

Material:
Aluminium/steel/glass

Recommended bulb:
7W, 2700K, 285lm, EEK=A
508800



Dimensions:
W/H/D: 9,5/41/11 cm
Glass-Ø/H: 7/18,5 cm
Canopy-Ø/H: 9,5/2,5 cm



DENA 1



Socket/Bulb:
E14/AGL candle shape (excl.)
40W max.
or
E14/EnergySaver (excl.)
up to max. Ø/L: 5/9,6 cm

Material:
Aluminium/glass

Dimensions:
W/H/D: 8/20/10 cm

Versions:
alu brushed
Glass satined

Art. No.:
147519

Recommended bulb:
11W, 2700K, 575lm, EEK=A
508630



DENA 2



Socket/Bulb:
E14/AGL candle shape (excl.)
2x 40W max.
or
E14/EnergySaver (excl.)
up to max. Ø/L: 5/9,6 cm

Material:
Aluminium/glass

Dimensions:
W/H/D: 8/30/10 cm

Versions:
alu brushed
Glass satined

Art. No.:
147529

Recommended bulb:
11W, 2700K, 575lm, EEK=A
508630



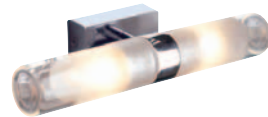

MIBO WALL UP-DOWN Design by FGL



230~ IP21

Socket/Bulb:
G9/G9 (excl.)
2x 25W max.

Versions:
chrome
Glass partial satined

Art. No.:
151282

Material:
Aluminium/glass

Dimensions:
W/H/D: 23/4/8,5 cm
Glass-Ø: 3,5 cm

Recommended bulb:
20W EnergySaver ≈ 25W
2700K, 200lm, EEC=D
519450





BIG SURA WALL

230~



Series: page 076



Socket/Bulb:
G9/G9 (excl.)
60W max.

Material:
Aluminium/ceramic

Dimensions:
Head-Ø/H: 9/9,5 cm
Canopy-W/H/D: 8/8/2,9 cm
Wall distance: 14 cm

Versions:
chrome
Ceramic white

Art. No.:
157242

Recommended bulb:
42W EnergySaver ≙ 60W
2700K, 620lm, EEC=C
519360



BIG SURA CEILING Design by CDC

230~



Series: page 076



Socket/Bulb:
G9/G9 (excl.)
60W max.

Material:
Steel/ceramic

Dimensions:
Shade-Ø/H: 9/9,5 cm
Canopy-Ø/H: 15/1,6 cm

Accessory/Included parts:
Canopy (incl.)

Versions:
chrome/white

Art. No.:
157232

Recommended bulb:
42W EnergySaver ≙ 60W
2700K, 620lm, EEC=C
519360



BLOX

230~



Socket/Bulb:
G9/G9 (excl.)
40W max.

Material:
Steel/glass

Dimensions:
Glass-L/W/H: 6,7/6,7/6,7 cm
Canopy-L/B: 9,5/9,5 cm
Total-H: 9 cm

Accessory/Included parts:
Canopy (incl.)

Versions:
chrome
Glass clear

Art. No.:
151240

Recommended bulb:
33W EnergySaver \approx 40W
2700K, 460lm, EEC=C
519451



BLOX 1

230~



Socket/Bulb:
G9/G9 (excl.)
40W max.

Material:
Aluminium/glass

Dimensions:
W/H/D: 7,4/10/10,5 cm
Glass-L/W/H: 6,7/6,7/6,7 cm

Accessory/Included parts:
Canopy (incl.)

Versions:
chrome
Glass clear

Art. No.:
151250

Recommended bulb:
33W EnergySaver \approx 40W
2700K, 460lm, EEC=C
519451



KOKO 1

230~



Socket/Bulb:
G9/G9 (excl.)
40W max.

Material:
Aluminium/glass

Dimensions:
W/H/D: 8/9/11 cm

Accessory/Included parts:
Canopy (incl.)

Versions:
alu brushed
Glass partial satined

Art. No.:
147469

Recommended bulb:
33W EnergySaver \approx 40W
2700K, 460lm, EEC=C
519451



KOKO 2

230~



Socket/Bulb:
G9/G9 (excl.)
2x 40W max.

Material:
Aluminium/glass

Dimensions:
W/H/D: 8/13,5/11 cm

Accessory/Included parts:
Canopy (incl.)

Versions:
alu brushed
Glass partial satined

Art. No.:
147479

Recommended bulb:
33W EnergySaver \approx 40W
2700K, 460lm, EEC=C
519451





TIGLA SQUARE

230~



Socket/Bulb:
GU10/GU10 (excl.)
50W max.

Material:
Aluminium/acrylic

Dimensions:
L/W/H: 8/8/11 cm

Versions:
alu brushed
Acrylic satined

Art. No.:
114740

Recommended bulb:
35W EnergySaver \approx 50W
20°, 2800K, 1200cd
575370



TIGLA ROUND

230~



Socket/Bulb:
GU10/GU10 (excl.)
50W max.

Material:
Aluminium/acrylic

Dimensions:
 \varnothing /H: 8,7/11,7 cm

Versions:
alu brushed
Acrylic satined

Art. No.:
114730

Recommended bulb:
35W EnergySaver \approx 50W
20°, 2800K, 1200cd
575370



ASTINA UP-DOWN

230~



350°



Socket/Bulb:
GU10/GU10 (excl.)
2x 50W max.

Material:
Aluminium/glass

Dimensions:
W/H/D: 7/20/12,5 cm

Versions:
silver grey
Glass satined

Art. No.:
151901

Recommended bulb:
35W EnergySaver \approx 50W
20°, 2800K, 1200cd
575370

LIMA UP-DOWN Design by CDC

230~



Series: page 247



Socket/Bulb:
GU10/GU10 (excl.)
2x 50W max.

Material:
Aluminium/glass

Dimensions:
W/H/D: 7/20,5/10 cm
Canopy-W/H/D: 5,5/20,5/2,5 cm

Versions:
chrome
silver grey

Art. No.:
157222
157224

Recommended bulb:
35W EnergySaver \approx 50W
20°, 2800K, 1200cd
575370



Note:
Grid insert is removable.

LIMA Design by CDC/FGI

230~



350°



180°



Series: page 247



Socket/Bulb:
GU10/GU10 (excl.)
50W max.

Material:
Aluminium/glass

Dimensions:
W/H/D: 8/15/12 cm

Versions:
chrome
silver grey

Art. No.:
157212
157214

Recommended bulb:
35W EnergySaver \approx 50W
20°, 2800K, 1200cd
575370



Note:
Grid insert is removable.





IGU WALL UP-DOWN

230~

Series: page 076

Socket/Bulb:
 GU10/GU10 (excl.)
 2x 50W max.

Material:
 Aluminium/glass

Dimensions:
 W/H/D: 11,5/21,5/11,5 cm

Versions:
 silver grey
 Glass white satined
 Glass smoky grey

Art. No.:
 157181
 157182

Recommended bulb:
 35W EnergySaver \approx 50W
 20°, 2800K, 1200cd
 575370

DARIUS

230~

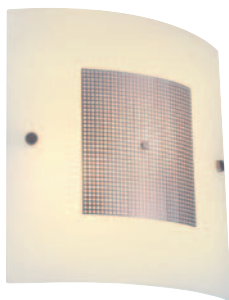
Socket/Bulb:
 E14/AGL Candle shape (excl.)
 2x 40W max.
 or
 E14/EnergySaver (excl.)
 up to max. \varnothing /L: 5/16,5 cm

Material:
 Steel/glass

Dimensions:
 W/H/D: 30/32/10 cm

Versions:
 silver grey
 Glass satined

Art. No.:
 151635

Recommended bulb:
 11W, 2700K, 530lm, EEK=A
 508810

LALU® WALL 1/2 Design by CDC

230~

Socket/Bulb:
 E27/EnergySaver (excl.)
 up to max. \varnothing /L: 4,5/17 cm
 15W max.

Material:
 Aluminium/acrylic

Dimensions:
 W/H/D: 25/27,5/15 cm

Versions:
 silver grey/white

Art. No.:
 229512

Recommended bulb:
 15W, 2700K, 800lm, EEK=A
 508960

Note:
 The lamp achieves IP43 under the condition that the lamp is mounted with the bracket pointing downwards.



CYLOVA

230~

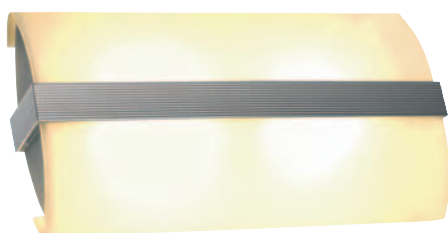

Socket/Bulb:
R7s/R7s, 78 mm (excl.)
2x 100W max.

Material:
Steel/glass

Dimensions:
W/H/D: 24,5/46/8,5 cm

Versions:
silver grey
Glass satined

Art. No.:
151624

Recommended bulb:
100W EnergySaver \neq 150W
2700K, 1900lm, EEK=C
519215



ZENIT

230~



Socket/Bulb:
G24d-2/
TC-D EnergySaver (excl.)
18W

Material:
Aluminium/glass

Dimensions:
W/H/D: 29,5/25/14 cm

Accessory/Included parts:
Low-loss ballast (incl.)

Versions:
silver grey
Glass satined

Art. No.:
151932

Recommended bulb:
18W, 2700K, 1200lm, EEK=B
508218



CREST 1

230~



Socket/Bulb:
R7s/R7s, 78 mm (excl.)
100W max.

Material:
Steel/glass

Dimensions:
W/H/D: 20/30/10 cm

Versions:
silver grey
Glass satined

Art. No.:
151695

Recommended bulb:
100W EnergySaver \neq 150W
2700K, 1900lm, EEK=C
519215

CREST 2

230~



Socket/Bulb:
R7s/R7s, 78 mm (excl.)
100W max.

Material:
Steel/glass

Dimensions:
W/H/D: 20/30/10 cm

Versions:
silver grey
Glass satined

Art. No.:
151691

Recommended bulb:
100W EnergySaver \neq 150W
2700K, 1900lm, EEK=C
519215





KARDAMOD SURFACE LED

230~

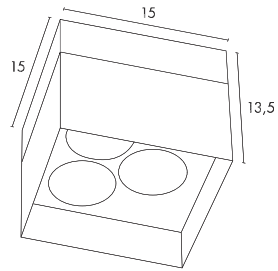
Bulb:
PowerLED (incl.)
9x 1W

Material:
Steel/aluminium

Dimensions:
L/W/H: 15/15/13,5 cm

Accessory/Included parts:
LED converter (incl.)

Versions:
alu anodized
LED white ▼
LED warm white ▼

Art. No.:
115501
115502

KARDAMOD SURFACE QRB Single *Design by CDC*230~
12~

Socket/Bulb:
G53/QRB111 (excl.)
75W max.

Material:
Steel

Dimensions:
L/W/H: 15,5/15,5/17,5 cm

Accessory/Included parts:
Electronic transformer (incl.)

Versions:
silver grey

Art. No.:
117124

Recommended bulb:
75W, 2700K
24°, 3000cd 543724
45°, 950cd 543745



Dimmable with trailing-edge phase dimmer.

KARDAMOD SURFACE QRB Double *Design by CDC*230~
12~

Socket/Bulb:
G53/QRB111 (excl.)
2x 75W max.

Material:
Steel

Dimensions:
L/W/H: 31,5/15,5/17,5 cm

Accessory/Included parts:
Electronic transformer (incl.)

Versions:
silver grey

Art. No.:
117134

Recommended bulb:
75W, 2700K
24°, 3000cd 543724
45°, 950cd 543745



Dimmable with trailing-edge phase dimmer.

KARDAMOD SURFACE ES111 Single *Design by CDC*

230~



Socket/Bulb:
GU10/ES111 (excl.)
75W max.

Material:
Steel

Dimensions:
L/W/H: 15,5/15,5/15,5 cm

Versions:
silver grey

Art. No.:
117104

Recommended bulb:
75W, 24°, 2700K, 2000cd
575672

KARDAMOD SURFACE ES111 Double *Design by CDC*

230~



Socket/Bulb:
GU10/ES111 (excl.)
2x 75W max.

Material:
Steel

Dimensions:
L/W/H: 31,5/15,5/15,5 cm

Versions:
silver grey

Art. No.:
117114

Recommended bulb:
75W, 24°, 2700K, 2000cd
575672







SCHNEPPES TONIC	2.00
SCHNEPPES AERUM	2.00
GINI	1.00
COLA / LIGHT / ZERO	2.00
FRUITA	2.00
NESTLE	2.00
PERrier	2.00
CHAUDFONTAINE BLAU	2.00
CHAUDFONTAINE ROSE	1.00
SPRITE	1.00
CANADA DRY	1.00
REDBULL LIGHT	3.00
MINUTE MAD	2.00
STELLA	2.00
ZUPLER	2.00
HOBGARDEN	1.00
DE JONCK	3.00
VEPPEIT	3.00
TAVEL	2.50
CARLSBERG	3.00
CORONA	3.00
KUIEK	2.50

KOFFIE
MOKKA
DUBBELE MOKKA
DECAFFEINE
CAFFUCCINO
LATT RUSSE
GHEDDOCCINO
WARMING CHOCO
THEE
VERSE HUNTREE
ANARETTO
BAILEYS
AVERNA
COMTEAU
SAMBAL
GRAPPA
LIMONCELLO
GRAND MARNIER
CAVENDISH
TORE WILLIAMS
REMY MARTIN COEUR
REMY V.S.O.P
REMY EXTRA
REMY X.O.



Art. No.: 117201



Art. No.: 117202



Art. No.: 117221



Art. No.: 117222

ACRYLIC BOX MR16 Single/Double

Material:
PMMA

Recommended bulb:
50W, 40°, 2700K, 1500cd
536540

Accessory/Included parts:
Electronic transformer (incl.)

Note:
Dimmable with trailing-edge phase dimmer.

ACRYLIC BOX GU10 Single/Double
Material:
PMMA

Recommended bulb:
35W EnergySaver ± 50W
20°, 2800K, 1200cd
575370

ACRYLIC BOX MR16/GU10 Single/Double

Article No.	Description	Colour	Voltage	Socket/ Bulb (excl.)	Wattage bulb	Length in cm	Width in cm	Height in cm	Weight
117201	Acrylic box Single MR16	black/translucent	230V AC/12V AC	G5,3/MR16	50W max.	12,6	12,6	15,7	0,73 kg
117202	Acrylic box Double MR16	black/translucent	230V AC/12V AC	G5,3/MR16	2x 50W max.	24,5	12,6	15,7	1,35 kg
117221	Acrylic box Single GU10	black/translucent	230V AC	GU10/GU10	50W max.	12,6	12,6	15,2	0,6 kg
117222	Acrylic box Double GU10	black/translucent	230V AC	GU10/GU10	2x 50W max.	24,5	12,6	15,2	0,97 kg



Art. No.: 117211



Art. No.: 117212



Art. No.: 117231



Art. No.: 117232

ACRYLIC BOX QRB111 Single/Double
Material:
PMMA

Recommended bulb:
50W EnergySaver ± 75W
545752, 24°, 3000K, 5800cd
545753, 40°, 3000K, 2000cd

Accessory/Included parts:
Electronic transformer (incl.)

Note:
Dimmable with trailing-edge phase dimmer.

ACRYLIC BOX ES111 Single/Double
Material:
PMMA

Recommended bulb:
75W, 24°, 2700K, 2000cd
575672

ACRYLIC BOX QRB111/ES111 Single/Double

Article No.	Description	Colour	Voltage	Socket/ Bulb (excl.)	Wattage bulb	Length in cm	Width in cm	Height in cm	Weight
117211	Acrylic box Single QRB111	black/translucent	230V AC/12V AC	G53/QRB111	75W max.	15	15	17	0,82 kg
117212	Acrylic box Double QRB111	black/translucent	230V AC/12V AC	G53/QRB111	2x 50W max.	29,4	15	17	1,22 kg
117231	Acrylic box Single ES111	black/translucent	230V AC	GU10/ES111	75W max.	15	15	178	0,84 kg
117232	Acrylic box Double ES111	black/translucent	230V AC	GU10/ES111	2x 75W max.	29,4	15	178	1,43 kg



JESSY CL-1 ES111



Socket/Bulb:
GU10/ES111 (excl.)
75W max.

Material:
Aluminium/steel

Dimensions:
W/H/D: 13/12,5/14,5 cm

Versions:
white

Art. No.:
147041

Recommended bulb:
75W, 24°, 2700K, 2000cd
575672



Recommended bulb:
PowerLED 10W, 40°, 460lm
550352 warm white



JESSY WL-2 ES111



Socket/Bulb:
GU10/ES111 (excl.)
75W max.

Material:
Aluminium/steel

Dimensions:
W/H/D: 15,2/21/14 cm
Canopy-W/H/D: 12/4,5/2 cm

Versions:
white

Art. No.:
147011

Recommended bulb:
75W, 24°, 2700K, 2000cd
575672



Recommended bulb:
PowerLED 10W, 25°, 460lm
550342 warm white



JESSY WL-1 QRB

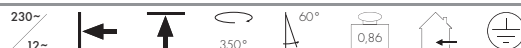

Socket/Bulb:
G53/QRB111 (excl.)
75W max.

Material:
Aluminium/steel

Dimensions:
W/H/D: 15,3/28,5/13 cm
Canopy-W/H/D: 10,5/10,5/3,5 cm

Versions:
white

Art. No.:
147001

Recommended bulb:
50W EnergySaver ≙ 75W
24°, 3000K, 5800cd 545752
40°, 3000K, 2000cd 545753



Accessory/Included parts:
Electronic transformer (incl.)

JESSY WL-3 G9

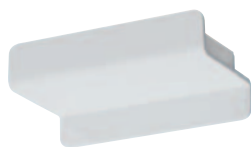

Socket/Bulb:
G9/G9 (excl.)
42W max.

Material:
Aluminium/steel

Dimensions:
W/H/D: 17/6/8 cm

Versions:
white

Art. No.:
147021

Recommended bulb:
33W EnergySaver ≙ 40W
2700K, 460lm, EEK=C
519451



JESSY WL-4 LED

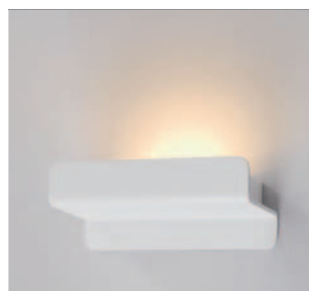

Bulb:
Planar LED (incl.)
4W total

Material:
Aluminium/steel

Dimensions:
W/H/D: 17/6/8 cm

Accessory/Included parts:
LED converter (incl.)

Versions:
white, 3000K

Art. No.:
147031





RETROSIX QRB 1

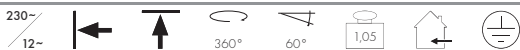

Socket/Bulb:
G53/QRB111 (excl.)
50W max.

Versions:
alu brushed
clear
black

Art. No.:
147581
147591

Material:
Steel/acrylic

Dimensions:
L/W/H: 23,5/17/12 cm

Accessory/Included parts:
Electronic transformer (incl.)

Recommended bulb:
50W, 45°, 2700K, 700cd
543545



RETROSIX QRB 2

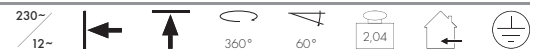

Socket/Bulb:
G53/QRB111 (excl.)
2x 50W max.

Versions:
alu brushed
clear
black

Art. No.:
147582
147592

Material:
Steel/acrylic

Dimensions:
L/W/H: 40,4/17/12 cm

Accessory/Included parts:
Electronic transformer (incl.)

Recommended bulb:
50W, 45°, 2700K, 700cd
543545





Series: page 046, 063



AIXLIGHT® KARDAFRAME WALL GU10 Design by CDC



Socket/Bulb:
GU10/GU10 (excl.)
50W max.

Versions:
silver grey

Art. No.:
154292

Material:
Aluminium

Dimensions:
L/W/H: 20,8/13/7,5 cm

Recommended bulb:
35W EnergySaver ± 50W
20°, 2800K, 1200cd
575370



Series: page 046, 064



AIXLIGHT® KARDAFRAME WALL QRB111 Design by CDC



Socket/Bulb:
G53/QRB111 (excl.)
50W max.

Versions:
silver grey

Art. No.:
154262

Material:
Aluminium

Dimensions:
L/W/H: 25,5/19/3 cm

Recommended bulb:
50W EnergySaver ± 75W
24°, 3000K, 5800cd
545752



Accessory/Included parts:
Electronic transformer (incl.)



KALU 1/2/3 Design by CDC



Material:
Aluminium

Series: page 038, 320



Accessory/Included parts:
Electronic transformer (incl.)

Recommended bulb for Kalu 1 and 2:
50W EnergySaver \approx 75W
545752, 24°, 3000K, 5800cd
545753, 40°, 3000K, 2000cd



Recommended bulb for Kalu 3:
35W EnergySaver \approx 50W
24°, 3000K, 4500cd
545522



Article No.	Description	Colour	Voltage	Socket/ Bulb (excl.)	Wattage bulb	Length in cm	Width in cm	Height in cm	Weight
147256	Kalu 1	alu brushed	230V AC/12V AC	G53/QRB111	50W max.	15	9	19	0,5 kg
147266	Kalu 2	alu brushed	230V AC/12V AC	G53/QRB111	2x 50W max.	30	9	19	0,9 kg
147276	Kalu 3	alu brushed	230V AC/12V AC	G53/QRB111	3x 35W max.	45	9	19	1,3 kg





The Kalu 2 ES111 lamps can be modified with the DomeLED ES111 bulb to LED technology.

KALU 2 ES111

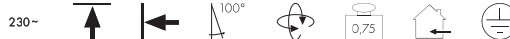

Series: page 038

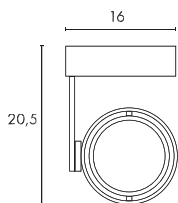

Socket/Bulb:
GU10/ES111 (excl.)
75W max.
or
DomeLED ES111 (excl.)
9W

Material:
Aluminium

Recommended bulb:
75W, 24°, 2700K, 2000cd
575672



Dimensions:
W/H/D: 16/20,5/16 cm

Versions:
alu brushed

Art. No.:
147706

Recommended bulb:
DomeLED 9W, 60°, 176lm
550392 warm white



KALU 2 ES111 DOUBLE



Series: page 038

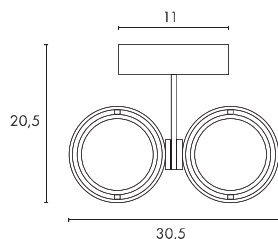

Socket/Bulb:
GU10/ES111 (excl.)
2x 75W max.
or
DomeLED ES111 (excl.)
2x 9W

Material:
Aluminium

Recommended bulb:
75W, 24°, 2700K, 2000cd
575672



Dimensions:
W/H/D: 30,5/20,5/16 cm

Versions:
alu brushed

Art. No.:
147716

Recommended bulb:
DomeLED 9W, 60°, 176lm
550392 warm white



KALU 2 LED 3



LED
LEDTEC

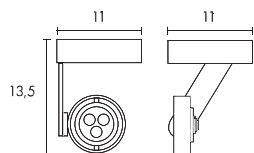
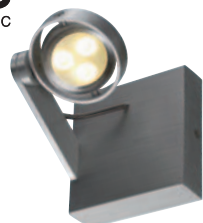

Bulb:
Power LED (incl.)
3x 1W

Material:
Aluminium

Dimensions:
W/H/D: 11/13,5/11 cm

Accessory/Included parts:
LED converter (incl.)

Versions:
alu brushed
LED warm white

Art. No.:
147762

KALU 2 LED 2x3



LED
LEDTEC

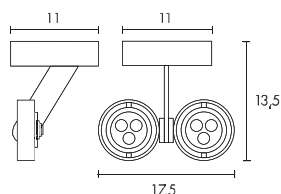

Bulb:
Power LED (incl.)
6x 1W

Material:
Aluminium

Dimensions:
W/H/D: 17,5/13,5/11 cm

Accessory/Included parts:
LED converter (incl.)

Versions:
alu brushed
LED warm white

Art. No.:
147772





TEC KARDA 2/4/6

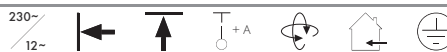

Material:
Aluminium

Accessory/Included parts:
Electronic transformer (incl.)
Suspension set (excl.)

Note:
With the optimal suspension set (149150) a pendant application is possible.

Recommended bulb:
35W EnergySaver \approx 50W
545522, 24°, 3000K, 4500cd



Article No.	Description	Colour	Voltage	Socket/ Bulb (excl.)	Wattage bulb	Length in cm	Width in cm	Height in cm	Weight
149142	Tec 2 Karda	silver grey	230V AC/12V AC	G53/QRB111	2x50W max.	14,0	32,0	17,5	0,85 kg
149144	Tec 4 Karda	silver grey	230V AC/12V AC	G53/QRB111	4x50W max.	30,5	32,0	17,5	1,55 kg
149146	Tec 6 Karda	silver grey	230V AC/12V AC	G53/QRB111	6x50W max.	49,0	32,0	17,5	2,30 kg

ACCESSORY for TEC Karda 2/4/6

Suspension set
Wire suspension-L/cable-L: 2,5 m
Cable 3x 0,75 mm²
Weight: 0,5 kg
149150





ASTO 1/2/3/4



Material:
Aluminium

Accessory/Included parts:
Deco rings for GU10 (incl.)

Recommended bulb:
35W EnergySaver # 50W
20°, 2800K, 1200cd
575370



Recommended bulb:
PowerLED 3W, 150lm
550842, warm white



Recommended bulb:
50W, 24°, 2700K, 1300cd
575652



Recommended bulb:
PowerLED 4W, 25°, 600cd, 240lm
560013, 3000K



PHILIPS

Recommended bulb:
DomeLED 9W, 60°, 176lm
550392 warm white



Article No.	Description	Colour	Voltage	Socket/ Bulb (excl.)	Wattage bulb	Length in cm	Width in cm	Height in cm	Weight
147441	Asto 1	alu brushed	230V AC	GU10/GU10 + ES111	50W max.	12,0	6,5	10,0	0,25 kg
147442	Asto 2	alu brushed	230V AC	GU10/GU10 + ES111	2x 50W max.	26,0	6,5	10,0	0,35 kg
147443	Asto 3	alu brushed	230V AC	GU10/GU10 + ES111	3x 50W max.	45,5	6,5	10,0	0,55 kg
147444	Asto 4	alu brushed	230V AC	GU10/GU10 + ES111	4x 50W max.	63,0	6,5	10,0	0,80 kg



Art. No.: 147559

INDA SPOT GU10**Material:**
Aluminium**Accessory/Included parts:**
Canopy (incl.)**Recommended bulb:**
35W EnergySaver \approx 50W
20°, 2800K, 1200cd
575370

Art. No.: 131108

N-TIC SPOT 230V Design by CDC**Material:**
Steel**Accessory/Included parts:**
Canopy (incl.)**Recommended bulb:**
35W EnergySaver \approx 50W
20°, 2800K, 1200cd
575370

Art. No.: 132024

SPOT 79 230V**Material:**
Aluminium**Accessory/Included parts:**
Canopy (incl.)**Recommended bulb:**
35W EnergySaver \approx 50W
20°, 2800K, 1200cd
575370

Art. No.: 132010

SPOT 79 12V**Material:**
Aluminium**Accessory/Included parts:**
Transformer (excl.)
Canopy (incl.)**Recommended bulb:**
50W, 40°, 2700K, 1500cd
536540**SPOTS**

Article No.	Description	Colour	Voltage	Socket/ Bulb (excl.)	Wattage bulb	Ø in cm	Length in cm	Width in cm	Height in cm	Canopy- Ø/H in cm	Rotation / swivel range	Weight
147559	Inda Spot GU10	alu brushed	230V AC	GU10/GU10	50W max.	6,0	-	-	15,8	6,0/2,5	180°/350°	0,30 kg
131108	N-Tic Spot 230V	chrome matt	230V AC	GU10/GU10	50W max.	-	8,0	9,0	16,5	6,0/2,5	90°/350°	0,60 kg
132020	Spot 79 230V	black	230V AC	GU10/GU10	50W max.	-	-	9,5	15	8,5/2,5	180°/350°	0,25 kg
132021	Spot 79 230V	white	230V AC	GU10/GU10	50W max.	-	-	9,5	15	8,5/2,5	180°/350°	0,25 kg
132024	Spot 79 230V	silver grey	230V AC	GU10/GU10	50W max.	-	-	9,5	15	8,5/2,5	180°/350°	0,25 kg
132010	Spot 79 12V	black	12V AC	G5,3/MR16	50W max.	-	-	7,3	12,5	5,4/2,0	180°/350°	0,30 kg
132011	Spot 79 12V	white	12V AC	G5,3/MR16	50W max.	-	-	7,3	12,5	5,4/2,0	180°/350°	0,30 kg
132014	Spot 79 12V	silver grey	12V AC	G5,3/MR16	50W max.	-	-	7,3	12,5	5,4/2,0	180°/350°	0,30 kg



Art. No.: 157304

HURIT SINGLE Design by CDC**Material:**
Aluminium**Recommended bulb:**
75W, 24°, 2700K, 2000cd
575672

Art. No.: 157314

HURIT TWIN Design by CDC**Material:**
Aluminium**Recommended bulb:**
75W, 24°, 2700K, 2000cd
575672

Art. No.: 147431

ASTO GLASS 1**Material:**
Aluminium/glass**Dimensions:**
Head-Ø/L: 6,5/14,5 cm**Recommended bulb:**
9W, 2700K, 420lm, EEK=A
508980

Art. No.: 147432

ASTO GLASS 2**Material:**
Aluminium/glass**Dimensions:**
Head-Ø/L: 6,5/14,5 cm**Recommended bulb:**
9W, 2700K, 420lm, EEK=A
508980**ASTO GLASS / HURIT**

230-



Article No.	Description	Colour	Voltage	Socket/ Bulb (excl.)	Wattage bulb	Width in cm	Height in cm	Depth in cm	Canopy L/W/H in cm	Rotation / swivel range	Weight
157304	Hurit Single	alu brushed/chrome	230V AC	GU10/GU10; ES111	75W max.	11,0	11,0	13,5	11/11/2,5	350°/180°	0,30 kg
157314	Hurit Twin	alu brushed/chrome	230V AC	GU10/GU10; ES111	2x 75W max.	11,0	11,0	30,0	11/11/2,5	350°/180°	0,45 kg
147431	Asto Glass 1	alu brushed/chrome/white	230V AC	GU10/GU10 or GU10 EnergySaver	35W max. up to max. Ø/L: 3,1/9 cm	6,5	16,0	12,5	12/6,5/2,5	350°/85°	0,32 kg
147432	Asto Glass 2	alu brushed/chrome/white	230V AC	GU10/GU10 or GU10 EnergySaver	2x 35W max. up to max. Ø/L: 3,1/9 cm	6,5	30,0	12,5	25/6,5/2,5	350°/85°	0,57 kg



ENNA Design by FGL

Series: page 080



Socket/Bulb:
GU10/GU10 (excl.)
50W max.

Material:
Aluminium

Dimensions:
W/H/D: 8/7/13 cm
Head-Ø: 7 cm

Versions:
silver grey

Art. No.:
151912

Recommended bulb:
35W EnergySaver \approx 50W
20°, 2800K, 1200cd
575370

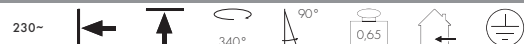
DIO Design by FGL

Series: page 080



Socket/Bulb:
GU10/GU10 (excl.)
2x 50W max.

Material:
Aluminium

Dimensions:
W/H/D: 15,5/7/13 cm
Head-Ø: 7 cm

Versions:
silver grey

Art. No.:
151922

Recommended bulb:
35W EnergySaver \approx 50W
20°, 2800K, 1200cd
575370



BARRO WL-1 Design by FGL

230~



Series: page 080

Socket/Bulb:
 GU10/GU10 (excl.)
 2x 50W max.

Material:
 Aluminium

Dimensions:
 W/H/D: 7/17/12 cm

Versions:
 silver grey

Art. No.:
 151910

chrome

151914

Recommended bulb:
 35W EnergySaver \approx 50W
 20°, 2800K, 1200cd
 575370

BARRO CL-1 Design by FGL

230~



Series: page 080

Socket/Bulb:
 GU10/GU10 (excl.)
 50W max.

Material:
 Aluminium

Dimensions:
 \varnothing /H: 7/8 cm

Versions:
 silver grey

Art. No.:
 116202

chrome

116204

Recommended bulb:
 35W EnergySaver \approx 50W
 20°, 2800K, 1200cd
 575370

E27 TUBE Design by CDC

230~

Socket/Bulb:
 E27/AGL (excl.)
 75W max.
 or
 E27/EnergySaver (excl.)

Material:
 Steel

Dimensions:
 \varnothing /H: 6/9,5 cm
 Canopy- \varnothing : 10 cm

Note:
 Not suitable for halogen bulbs.

Versions:
 chrome

Art. No.:
 111472



DomeLED CEILING



Bulb:
PowerLED (incl.)
6x 1W

Versions:
silver grey
LED white
LED warm white

Art. No.:
147331
147332

Material:
Aluminium

Dimensions:
Ø/H: 9,8/11,6 cm
Canopy-Ø/H: 8/5,6 cm

Accessory/Included parts:
LED converter (incl.)



Series: page 038, 071, 224, 225, 241, 256



LIGHT EYE Design by CDC



Socket/Bulb:
GU10/ES111 (excl.)
75W max.

Versions:
chrome

Art. No.:
149042

Material:
Aluminium/steel

Recommended bulb:
75W, 24°, 2700K, 2000cd
575672



Dimensions:
W/H: 15,5/20 cm
Head-Ø: 14,5 cm
Canopy-Ø/H: 8/3 cm

Recommended bulb:
DomeLED 9W, 60°, 176lm
550392 warm white



Accessory/Included parts:
Canopy (incl.)



LIGHT EYE BALL wall lamp



Socket/Bulb:
GU10/ES111 (excl.)
75W max.

Versions:
chrome/white

Art. No.:
149031

Material:
Steel

Recommended bulb:
75W, 24°, 2700K, 2000cd
575672



Dimensions:
Ø/H/D: 14,5/13/17,5 cm
Head-Ø/H: 14,5/13 cm
Canopy-W/H/D: 3,5/7/3 cm

Recommended bulb:
DomeLED 9W, 60°, 176lm
550392 warm white





ROX UP-DOWN

230~



Socket/Bulb:
GU10/ES111 (excl.)
2x 50W max.

Material:
Aluminium

Dimensions:
Ø/H/D: 12,5/20,5/13 cm

Versions:
alu natural

Art. No.:
149336

Recommended bulb:
50W, 24°, 2700K, 1300cd
575652



ROX WALL

230~



Socket/Bulb:
GU10/ES111 (excl.)
75W max.

Material:
Aluminium

Dimensions:
Ø/H/D: 12,5/16,1/13 cm

Versions:
alu natural

Art. No.:
149326

Recommended bulb:
75W, 24°, 2700K, 2000cd
575672



ROX CEILING

230~



Socket/Bulb:
GU10/ES111 (excl.)
75W max.

Material:
Aluminium

Dimensions:
Ø/H: 12,5/12,5 cm

Versions:
alu natural

Art. No.:
149316

Recommended bulb:
75W, 24°, 2700K, 2000cd
575672









THEO UP-DOWN Design by CDC

230~

**Socket/Bulb:**
GU10/GU10 (excl.)
2x 50W max.**Material:**
Aluminium**Dimensions:**
W/H/D: 7/22,5/7 cm**Versions:**
silver grey
alu brushed**Art. No.:**
152082
152089**Recommended bulb:**
35W EnergySaver \approx 50W
20°, 2800K, 1200cd
575370

BIG THEO UP-DOWN

230~

**Socket/Bulb:**
GU10/ES111 (excl.)
2x 75W max.**Material:**
Aluminium**Dimensions:**
W/H/D: 13/27/13,5 cm**Versions:**
silver grey**Art. No.:**
149294**Recommended bulb:**
75W, 24°, 2700K, 2000cd
575672

BIG THEO WALL

230~

**Socket/Bulb:**
GU10/ES111 (excl.)
75W max.**Material:**
Aluminium**Dimensions:**
W/H/D: 13/13,5/13 cm**Versions:**
silver grey**Art. No.:**
149284**Recommended bulb:**
75W, 24°, 2700K, 2000cd
575672

BIG THEO CEILING

230~

**Socket/Bulb:**
GU10/ES111 (excl.)
75W max.**Material:**
Aluminium**Dimensions:**
L/W/H: 13/13/14 cm**Versions:**
silver grey**Art. No.:**
149274**Recommended bulb:**
75W, 24°, 2700K, 2000cd
575672



The lamps of the Altra Dice series can be equipped with energy-saving bulbs as well as LED bulbs.

ALTRA DICE SPOT 1 Design by FGL

230~

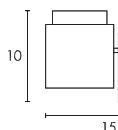

Socket/Bulb:
GU 10/GU 10 (excl.)
50W max.

Material:
Aluminium/steel

Dimensions:
L/W/H: 15/7/10 cm

Versions:
silver grey/black

Art. No.:
151524

Recommended bulb:
35W EnergySaver \approx 50W
20°, 2800K, 1200cd
575370



ALTRA DICE SPOT 2 Design by FGL

230~

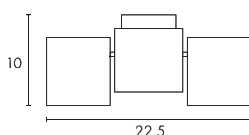

Socket/Bulb:
GU 10/GU 10 (excl.)
2x 50W max.

Material:
Aluminium/steel

Dimensions:
L/W/H: 22,5/7/10 cm

Versions:
silver grey/black

Art. No.:
151534

Recommended bulb:
35W EnergySaver \approx 50W
20°, 2800K, 1200cd
575370



ALTRA DICE WL-1 Design by FGL

230~

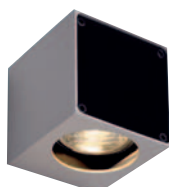

Socket/Bulb:
GU 10/GU 10 (excl.)
35W max.

Material:
Aluminium/steel

Dimensions:
L/W/D: 7/7/8 cm

Versions:
silver grey/black

Art. No.:
151504

Recommended bulb:
35W, 50°, 2700K, 270cd
575351



ALTRA DICE CL-1 Design by FGL

230~

Socket/Bulb:
 GU10/GU10 (excl.)
 35W max.

Material:
 Aluminium/steel

Dimensions:
 L/W/D: 7/7/10 cm

Versions:
 silver grey/black

Art. No.:
 151514

Recommended bulb:
 35W, 50°, 2700K, 270cd
 575351

ALTRA DICE WL-2 Design by FGL

230~

Socket/Bulb:
 GU10/GU10 (excl.)
 50W max.

Material:
 Aluminium/steel

Dimensions:
 W/H/D: 7/30/7 cm

Versions:
 white/black
 silver grey/black

Art. No.:
 151561
 151564

Recommended bulb:
 PowerLED 3W, 150lm
 550842, warm white

Recommended bulb:
 PowerLED 4W, 25°, 600cd, 240lm
 560013, 3000K

with PowerLED GU 10 bulb (550842)



SQUARE DICE 1 Design by CDC/FGL

230~

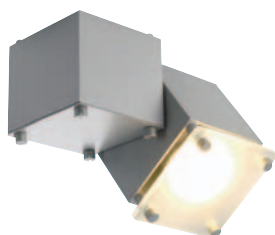

Socket/Bulb:
GU10/GU10 (excl.)
50W max.

Versions:
silver grey
Glass satined

Art. No.:
151132

Material:
Aluminium/glass

Dimensions:
W/H/D: 14/7,5/11,5 cm

Recommended bulb:
35W EnergySaver ≈ 50W
20°, 2800K, 1200cd
575370



Recommended bulb:
7W, 2700K, 120lm
508850



SQUARE DICE 2 Design by CDC/FGL

230~



Socket/Bulb:
GU10/GU10 (excl.)
2x 50W max.

Versions:
silver grey
Glass satined

Art. No.:
151142

Material:
Aluminium/glass

Dimensions:
W/H/D: 21,5/7,5/11,5 cm

Recommended bulb:
35W EnergySaver ≈ 50W
20°, 2800K, 1200cd
575370



Recommended bulb:
7W, 2700K, 120lm
508850



SQUARE DISI Design by CDC

230~

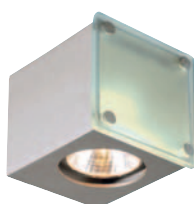

Socket/Bulb:
GZ10/GU10; GZ10 (excl.)
35W max.

Versions:
silver grey
Glass satined

Art. No.:
151392

Material:
Aluminium/glass

Dimensions:
W/H/D: 7/7/9,7 cm

Recommended bulb:
35W, 50°, 2700K, 270cd
575351



SQUARE WALL Design by FGL

230~

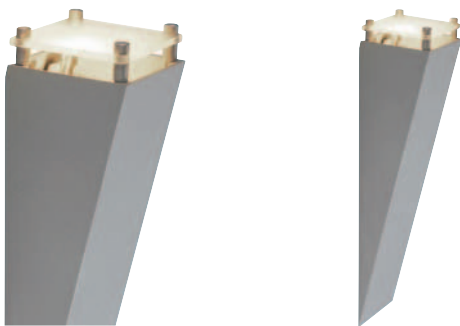
Socket/Bulb:
 GU10/GU10 (excl.)
 50W max.

Versions:
 silver grey
 Glass satined

Art. No.:
 151390

Material:
 Aluminium/glass

Dimensions:
 W/H/D: 7/32,5/7 cm

Recommended bulb:
 35W EnergySaver \neq 50W
 20°, 2800K, 1200cd
 575370

Recommended bulb:
 7W, 2700K, 120lm
 508850

SQUARE GU10 Design by CDC/FGL

230~

Socket/Bulb:
 GU10/GU10 (excl.)
 35W max.

Versions:
 silver grey
 Glass satined

Art. No.:
 112420

Material:
 Aluminium/glass

Dimensions:
 W/H/D: 7/11/7 cm

Recommended bulb:
 35W, 50°, 2700K, 270cd
 575351

Recommended bulb:
 7W, 2700K, 120lm
 508850



ENOLA_B SPOT 1

230~

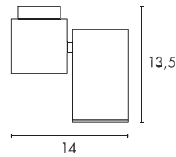

Socket/Bulb:
GU10/GU10 (excl.)
up to max. L: 8 cm
50W max.

Material:
Aluminium/steel

Dimensions:
W/H/D: 14/13,5/6,7 cm

Versions:
white
silver grey/black

Art. No.:
151821
151824

Recommended bulb:
11W EnergySaver, 2700K, 220lm
508920



Recommended bulb:
PowerLED 4W, 25°, 600cd, 240lm
560013, 3000K



ENOLA_B SPOT 2

230~

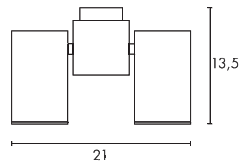

Socket/Bulb:
GU10/GU10 (excl.)
up to max. L: 8 cm
2x 50W max.

Material:
Aluminium/steel

Dimensions:
W/H/D: 21/13,5/6,7 cm

Versions:
white
silver grey/black

Art. No.:
151831
151834

Recommended bulb:
11W EnergySaver, 2700K, 220lm
508920



Recommended bulb:
PowerLED 4W, 25°, 600cd, 240lm
560013, 3000K



ENOLA_B CL-1

230~

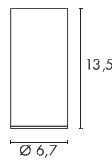

Socket/Bulb:
GU10/GU10 (excl.)
up to max. L: 8,5 cm
35W max.

Material:
Aluminium

Dimensions:
Product Ø/H: 6,7/13,5 cm

Versions:
white
silver grey/black

Art. No.:
151811
151814

Recommended bulb:
11W EnergySaver, 2700K, 220lm
508920



Recommended bulb:
PowerLED 4W, 25°, 600cd, 240lm
560013, 3000K



ENOLA_B UP-DOWN

230~

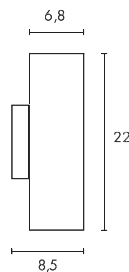

Socket/Bulb:
GU10/GU10 (excl.)
up to max. L: 8,5 cm
50W max.

Material:
Aluminium/steel

Dimensions:
W/H/D: 6,8/22/8,5 cm

Versions:
white
silver grey/black

Art. No.:
151801
151804

Recommended bulb:
11W EnergySaver, 2700K, 220lm
508920



Recommended bulb:
PowerLED 4W, 25°, 600cd, 240lm
560013, 3000K



ACCESSORY for Enola_B



Decoration ring
black
Steel
Ø/H: 0,64/0,24 cm

Art. No.:
151840



The lamps of the Enola_B series can be equipped with energy-saving bulbs as well as LED bulbs.





DACU SPACE

230~
12=LED
9 pce.

0,32





Bulb:
LED (incl.)
9x0,5W

Material:
Aluminium

Accessory/Included parts:
LED converter (incl.)

Versions:
LED warm white
black/white
white/white
alu brushed/white

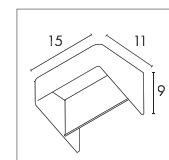
Art. No.:
151470
151471
151476





LED SHELL

230~ 1 pce. 0,4



Bulb:
PowerLED (incl.)
4W

Material:
Aluminium

Dimensions:
Ø/D: 18/7,3 cm

Versions:
LED warm white
black, high gloss finished
white, high gloss finished

Art. No.:
151370
151371

LED SAIL 1

230~ 700 1 pce. 60° 0,75



Bulb:
PowerLED (incl.)
3W

Material:
Aluminium/steel

Dimensions:
W/H/D: 21/20/6 cm

Accessory/Included parts:
LED converter (incl.)

Versions:
LED warm white
black, high gloss finished
white, high gloss finished

Art. No.:
151600
151601

LED SAIL 2

230~ 700 2 pce. 60° 0,94



Bulb:
PowerLED (incl.)
2x 3W

Material:
Aluminium/steel

Dimensions:
W/H/D: 21/30/6 cm

Accessory/Included parts:
LED converter (incl.)

Versions:
LED warm white
black, high gloss finished
white, high gloss finished

Art. No.:
151610
151611



DACU UP-DOWN

230~



IP44

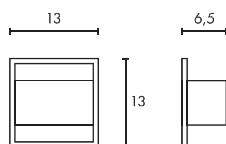

Socket/Bulb:
G9/G9 (excl.)
40W max.



Material:
Aluminium

Versions:
silver grey
alu brushed

Art. No.:
227132
227136

Recommended bulb:
33W EnergySaver Δ 40W
2700K, 460lm, EEC=C
519451



DACU UP-DOWN LED

230~
mA
350LED
2 pce.

IP44

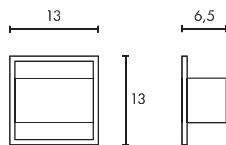

Bulb:
PowerLED (incl.)
2x 1W



Material:
Aluminium

Versions:
silver grey
LED white
LED warm white

Art. No.:
227261
227262

Accessory/Included parts:
LED converter (incl.)

DACU UP-DOWN LED BEAM

230~
mA
350LED
2 pce.

IP44

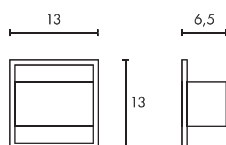

Bulb:
PowerLED (incl.)
2x 1W



Material:
Aluminium

Versions:
silver grey
LED white
LED warm white

Art. No.:
227251
227252

Accessory/Included parts:
LED converter (incl.)

DACU LED Design by CDC

 230~
mA
350
 LED
2 pce.
 ←
 0,35
 IP44
LED
LEDTEC

Bulb:
PowerLED (incl.)
2x 1W

Material:
Aluminium

Dimensions:
W/H/D: 13/13/6,5 cm

Accessory/Included parts:
LED converter (incl.)

Versions:
silver grey
LED white
LED warm white

Art. No.:

 152041
152042

DACU G9 Design by CDC

 230~
 ←

 0,4
 IP44

Socket/Bulb:
G9/G9 (excl.)
40W max.

Material:
Aluminium

Dimensions:
W/H/D: 13/13/6 cm

Versions:
silver grey
alu brushed

Art. No.:

 227102
227106

Recommended bulb:
33W EnergySaver ≈ 40W
2700K, 460lm, EEC=C
519451



HALF PIPE Design by CDC



Bulb:
PowerLED (incl.)
3x 1W

Material:
Aluminium

Dimensions:
W/H/D: 176/9/5,6 cm

Accessory/Included parts:
LED converter (incl.)

Versions:
alu brushed
LED white
LED warm white
LED blue

Art. No.:
149411
149412
149417

AITES 16 LED

12~



IP23

Bulb:
LED board (incl.)
1,5W total

Material:
Aluminium

Dimensions:
W/H/D: 9/9/1,8 cm
Supply line-L: 2 m

Accessory/Included parts:
Conventional transformer (excl.)

Versions:
alu brushed
LED white

Art. No.:
230251

Recommended transformer:

 Conventional transformer, 10VA, 12V~
451010

Note:
Operate only with conventional transformer.

AITES 20 LED

12~



IP23

Bulb:
LED board (incl.)
1,8W total

Material:
Aluminium

Dimensions:
W/H/D: 22,3/5/1,8 cm
Supply line-L: 2 m

Accessory/Included parts:
Conventional transformer (excl.)

Versions:
alu brushed
LED white

Art. No.:
230261

Recommended transformer:

 Conventional transformer, 10VA, 12V~
451010

Note:
Operate only with conventional transformer.



DELWA BLUE



230~
mA
350

LEDs
2 pce.



90°

0,45

IP44



Bulb:
PowerLED (incl.)
LED white 5W
LED blue 1W

Versions:
silver grey
LED white/blue

Art. No.:
230767

Material:
Aluminium/glass

Dimensions:
W/H/D: 6/18/6 cm

Accessory/Included parts:
LED converter (incl.)

Note:
With blue deco light.



DELWA



230~
mA
350

LED
1 pce.



90°

0,45

IP44



Bulb:
PowerLED (incl.)
5W

Versions:
silver grey
LED white
LED warm white

Art. No.:
230751
230752

Material:
Aluminium/glass

Dimensions:
W/H/D: 6/18/6 cm

Accessory/Included parts:
LED converter (incl.)



DELWA WIDE Design by CDC



230V
350mA

LED
2 pce.



0,8

IP44



Bulb:
Planar LED (incl.)
2x 3,5W

Material:
Aluminium/glass

Dimensions:
W/H/D: 14/18/6 cm

Accessory/Included parts:
LED converter (incl.)

Versions:
LED warm white
white
silver grey

Art. No.:
230791
230794

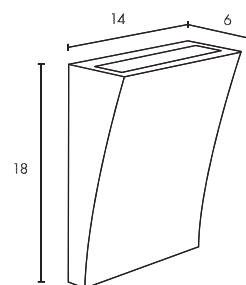

Delwa Wide

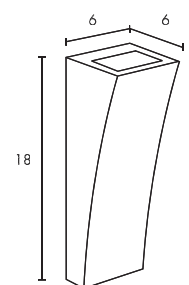

Delwa /Delwa Blue

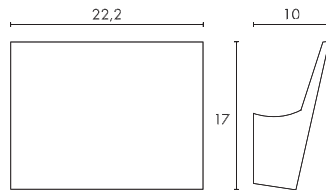

SOLF LED Design by FGL

Bulb:
LED (incl.)
9x 0,5W

Material:
Aluminium

Accessory/Included parts:
LED converter (incl.)

Versions:
LED warm white
black/chrome ▼
white ▼
silver grey ▼

Art. No.:
157620
157621
157624

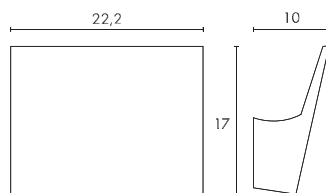
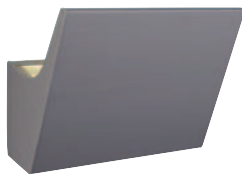
SOLF TC-D Design by FGL

Socket/Bulb:
G24d-3/TC-D EnergySaver (excl.)
26W

Material:
Aluminium

Accessory/Included parts:
Low-loss ballast (incl.)

Versions:
silver grey

Art. No.:
157604

Recommended bulb:
26W, 2700K, 1800lm, EEK=B
508226

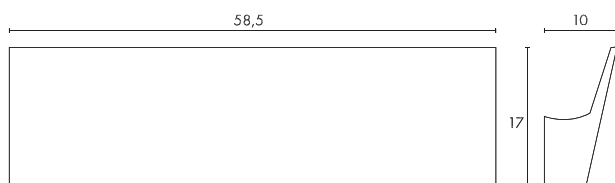
SOLF T5 Design by FGL

Socket/Bulb:
G5/T5 EnergySaver (excl.)
24W

Material:
Aluminium

Accessory/Included parts:
Electronic ballast (incl.)

Versions:
white/chrome

Art. No.:
157611

Recommended bulb:
24W, 3000K, 1700lm
548024

(PU see page 617)



Note:
The lamp can be mounted with
the light emission upwards or
downwards.



SLEEK LED UP-DOWN

230V
mA
350LED
2 pce.

20°



0,07



LEDTEC

Bulb:
PowerLED (incl.)
2x 1W

Material:
Aluminium

Dimensions:
W/H/D: 3,7/15/7 cm

Accessory/Included parts:
LED converter (incl.)

Versions:
LED warm white
white
silver grey

Art. No.:
151301
151304



AIDAN UP-DOWN



Bulb:
PowerLED (incl.)
2x 1W

Material:
Aluminium

Dimensions:
W/H/D: 4,6/9/7,5 cm

Accessory/Included parts:
LED converter (incl.)

Versions:
alu brushed
LED white
LED warm white

Art. No.:
151361
151362

ROX LED UP-DOWN Design by CDC

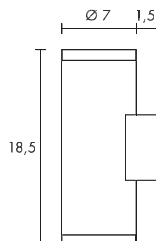

Bulb:
PowerLED (incl.)
2x 3W



Material:
Aluminium

Accessory/Included parts:
LED converter (incl.)

Versions:
alu brushed/varnished
LED white
LED warm white

Art. No.:
227231
227232



OVA WALL 1

230~



350°



Socket/Bulb:
GU10/GU10 (excl.)
2x 50W max.

Material:
Aluminium

Dimensions:
W/H/D: 6/28/13,5 cm

Versions:
silver grey

Art. No.:
147112

Recommended bulb:
35W EnergySaver ≈ 50W
20°, 2800K, 1200cd
575370



NEPRO WALL

230~



Series: page 217 250, 288

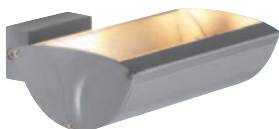

Socket/Bulb:
R7s/R7s, 118 mm (excl.)
200W max.

Material:
Aluminium

Dimensions:
W/H/D: 17,5/6/17 cm

Versions:
silver grey

Art. No.:
151982

Recommended bulb:
200W EnergySaver ≈ 300W
2700K, 4000lm, EEK=C
519223



ANDREAS LED Design by CDC

Bulb:
LED (incl.)
9x 0,5W

Material:
Aluminium

Dimensions:
W/H/D: 20,5/4,2/9,5 cm

Accessory/Included parts:
LED converter (incl.)

Versions:
LED warm white
white
silver grey

Art. No.:
151431
151434

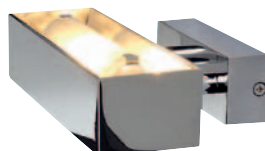
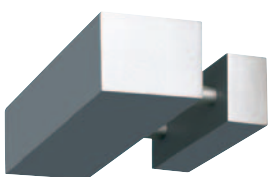
ANDREAS Design by CDC

Socket/Bulb:
R7s/R7s, 118 mm (excl.)
100W max.

Material:
Aluminium

Dimensions:
W/H/D: 20,5/5,5/11 cm

Versions:
silver grey

chrome

Art. No.:
151400

151404

Recommended bulb:
100W EnergySaver # 150W
2700K, 1900lm, EEK=C
519221



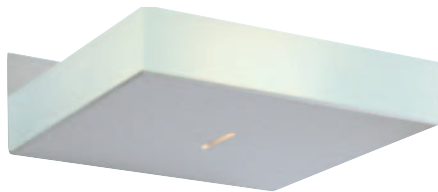

HARI



230~



Socket/Bulb:
G9/G9 (excl.)
40W max.

Versions:
Glass satined
silver grey

Art. No.:
151674

Material:
Steel/glass

Dimensions:
W/H/D: 12,5/2,5/13 cm

Recommended bulb:
33W EnergySaver \approx 40W
2700K, 460lm, EEK=C
519451



MINI BEAM Design by CDC



230~



Socket/Bulb:
G9/G9 (excl.)
40W max.

Versions:
silver grey

Art. No.:
151490

Material:
Aluminium

Dimensions:
W/H/D: 7/11/11 cm

Recommended bulb:
33W EnergySaver \approx 40W
2700K, 460lm, EEK=C
519451





NEW ANDREAS



230~

Socket/Bulb:
R7s/R7s, 118 mm (excl.)
100W max.

Versions:
Structure glass frosted
chrome

Art. No.:
151422

Material:
Aluminium/glass

silver grey

151424

Dimensions:
W/H/D: 18/7/9 cm

Recommended bulb:
100W EnergySaver \neq 150W
2700K, 1900lm, EEK=C
519221



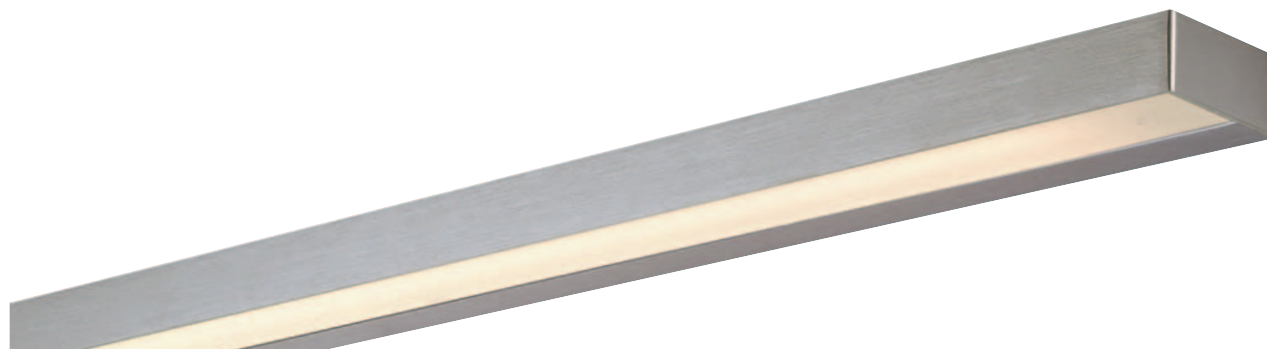

SEDO 14

230~



Note:
Cannot be used as a shelf!
For this application we recommend
the Flat series, see page 168.



Socket/Bulb:
G5/T5 EnergySaver (excl.)
14W

Material:
Aluminium/glass

Dimensions:
W/H/D: 59,5/4/8,5 cm

Accessory/Included parts:
Electronic ballast (incl.)

Versions:
Glass satined
alu brushed

Art. No.:
151762

Recommended bulb:
14W, 3000K, 1230lm
548014

(PU see page 617)



SEDO 21

230~



Note:
Cannot be used as a shelf!
For this application we recommend
the Flat series, see page 168.



Socket/Bulb:
G5/T5 EnergySaver (excl.)
21W

Material:
Aluminium/glass

Dimensions:
W/H/D: 89,5/4/8,5 cm

Accessory/Included parts:
Electronic ballast (incl.)

Versions:
Glass satined
alu brushed

Art. No.:
151772

Recommended bulb:
21W, 3000K, 1910lm
548021

(PU see page 617)



CHROMBO Design by CDC

230~

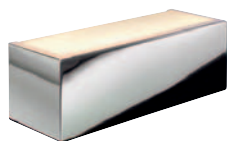

Socket/Bulb:
G9/G9 (excl.)
40W max.

Material:
Steel/glass

Dimensions:
W/H/D: 20/6,9/6,9 cm

Versions:
Structure glass, frosted
chrome

Art. No.:
151462

Recommended bulb:
33W EnergySaver \approx 40W
2700K, 460lm, EEK=C
519451



CHROMBO TC-S

230~



Socket/Bulb:
G23/TC-S EnergySaver (excl.)
11W max.

Material:
Steel/glass

Dimensions:
W/H/D: 30/10/9 cm

Accessory/Included parts:
Low-loss ballast (incl.)

Versions:
Glass satined
chrome

Art. No.:
155260

Recommended bulb:
11W, 2700K, 900lm, EEK=A
508310



BOWTOW GLASS

230~



IP21



Socket/Bulb:
G5/T5 EnergySaver (excl.)
24W



Material:
Steel/glass

Dimensions:
W/H/D: 64,5/4,5/10,5 cm

Accessory/Included parts:
Electronic ballast (incl.)
2 partial satined glass panes (incl.)

Note:
Mechanical load 3 kg max.

Versions:
chrome

Art. No.:
157472

Recommended bulb:
24W, 3000K, 1700lm
548024

(PU see page 617)

BOWTOW

230~



IP23



Socket/Bulb:
S14d/line bulb (excl.)
60W

Material:
Steel

Dimensions:
W/H/D: 57/4/10 cm

Versions:
chrome

Art. No.:
157322

Recommended bulb:
60W, 2700K, 420lm, EEK=G
50 cm, matt
590151

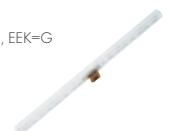



TANI

230~

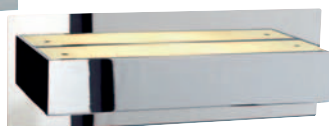

Socket/Bulb:
R7s/R7s, 118 mm (excl.)
200W max.

Material:
Aluminium/glass

Dimensions:
W/H/D: 23/8,5/8,5 cm

Versions:
chrome
alu brushed

Art. No.:
147562
147566

Recommended bulb:
200W EnergySaver Δ 300W
2700K, 4000lm, EEK=C
519223





WL 149 R7s

230~



Socket/Bulb:
R7s/R7s, 78 mm (excl.)
60W max.

Material:
Steel/glass

Dimensions:
W/H/D: 24/5/10 cm

Versions:
Glass stained/chrome

Art. No.:
149472

Recommended bulb:
48W EnergySaver $\hat{=}$ 60W
2700K, 750lm, EEC=C
519206





NEPRO LINE

230~

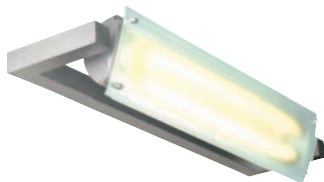

Socket/Bulb:
G5/T5 EnergySaver (excl.)
2x 24W

Material:
Aluminium/glass

Dimensions:
W/H/D: 70,5/14/20,5 cm

Accessory/Included parts:
Electronic ballast (incl.)

Versions:
silver grey

Art. No.:
157052

Recommended bulb:
24W, 3000K, 1700lm
548024

(PU see page 617)





ARLINA T5

230~



Socket/Bulb:
G5/T5 EnergySaver (excl.)
28W

Material:
Aluminium/glass

Dimensions:
L/W/H: 128/7,5/6 cm

Accessory/Included parts:
Electronic ballast (incl.)

Versions:
Glass satined
alu brushed

Art. No.:
155216

Recommended bulb:
28W, 3000K, 2640lm
548028

(PU see page 617)



WORKLIGHT WAVE WL-1

230~



Series: page 056



Socket/Bulb:
G5/T5 EnergySaver (excl.)
39W

Material:
Aluminium/acrylic

Dimensions:
W/H/D: 90/6/18 cm

Accessory/Included parts:
Electronic ballast (incl.)

Versions:
silver grey

Art. No.:
157584

Recommended bulb:
39W, 3000K, 3500lm
548039

(PU see page 617)



Note:
Calculated acrylic diffuser from BWF.



FLAT 221

230~

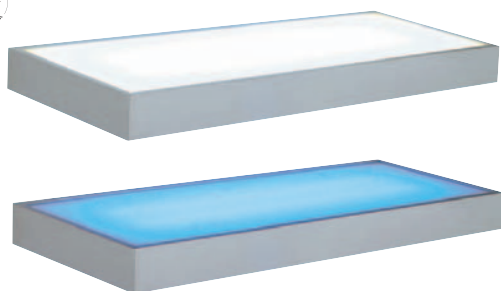

Socket/Bulb:
G5/T5 EnergySaver (excl.)
2x 21W

Material:
Aluminium/glass

Dimensions:
W/H/D: 91/5/22 cm

Note:
Mechanical load: 10 kg max.
The use of coloured T5 bulbs is possible.

Accessory/Included parts:
Electronic ballast (incl.)

Versions:
Glass satined
alu

Art. No.:
157202

Recommended bulb:
21W, 3000K, 1910lm
548021

[PU see page 617]



FLAT 121

230~

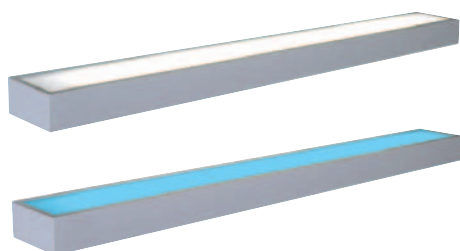

Socket/Bulb:
G5/T5 EnergySaver (excl.)
21W

Material:
Aluminium/glass

Dimensions:
W/H/D: 91/5/10 cm

Note:
Mechanical load: 15 kg max.
The use of coloured T5 bulbs is possible.

Accessory/Included parts:
Electronic ballast (incl.)

Versions:
Glass satined
alu

Art. No.:
157192

Recommended bulb:
21W, 3000K, 1910lm
548021

[PU see page 617]





SIGHT 24 Design by CDC



230~



Socket/Bulb:
G5/T5 EnergySaver (excl.)
24W

Versions:
silver grey
alu brushed

Art. No.:
160202
160206

Material:
Aluminium/acrylic

Dimensions:
L/W/H: 59/4/6 cm

Recommended bulb:
24W, 3000K, 1700lm
548024

Accessory/Included parts:
Electronic ballast (incl.)
Switch (incl.)

(PU see page 617)



SIGHT 54 Design by CDC



230~



Socket/Bulb:
G5/T5 EnergySaver (excl.)
54W

Versions:
silver grey
alu brushed

Art. No.:
160212
160216

Material:
Aluminium/acrylic

Dimensions:
L/W/H: 119/4/6 cm

Recommended bulb:
54W, 3000K, 5000lm
548054

Accessory/Included parts:
Electronic ballast (incl.)

(PU see page 617)





Q-LINE

DESIGN BY CDC

Series: page 052



Q-LINE WALL Design by CDC



230~



Socket/Bulb:
G5/T5 EnergySaver (excl.)
35W

Material:
Aluminium anodized
Diffusor acrylic

Dimensions:
W/H/D: 151/5,7/10,2 cm

Accessory/Included parts:
Electronic ballast (incl.)

Versions:
white/chrome
alu/anthracite

Art. No.:
155001
155002

Recommended bulb:
35W, 3000K, 3650lm
548035

(PU see page 617)



ACCESSORY for Q-Line Wall

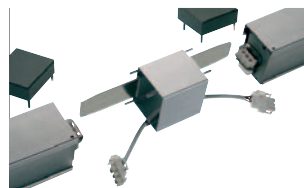

Longitudinal connector Art. No.:
white/chrome 155051
alu 155052

L/W/H: 6/5,7/5,1 cm
20 cm cable (incl.)
For the straight connection of two
Q-Line profiles.





L-LINE 60 Design by CDC

230~



IP43



Accessory/Included parts:
Electronic ballast (incl.)

Note:
Max. mechanical load: 3 kg



Socket/Bulb:
G5/T5 EnergySaver (excl.)
24W

Material:
Aluminium/PC

Dimensions:
Outer dimensions
W/H/D: 60/7/7 cm
Clearance dimensions
W/H/D: 60/3,5/3,5 cm

Versions:
silver grey

Art. No.:
157414

Recommended bulb:
24W, 3000K, 1700lm
548024

[PU see page 617]



L-LINE 120 Design by CDC

230~



IP43

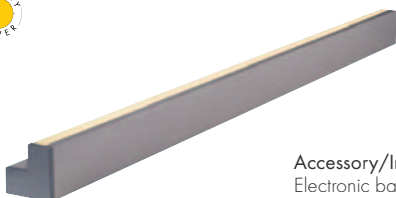

Accessory/Included parts:
Electronic ballast (incl.)

Note:
Max. mechanical load: 3 kg



Socket/Bulb:
G5/T5 EnergySaver (excl.)
28W

Material:
Aluminium/PC

Dimensions:
Outer dimensions
W/H/D: 120/7/7 cm
Clearance dimensions
W/H/D: 120/3,5/3,5 cm

Versions:
silver grey

Art. No.:
157424

Recommended bulb:
28W, 3000K, 2640lm
548028

[PU see page 617]



ONIO T5 Design by CDC

230~



Socket/Bulb:
G5/T5 EnergySaver (excl.)
24W

Material:
Aluminium

Dimensions:
W/H/D: 68/4,5/9 cm

Accessory/Included parts:
Electronic ballast (incl.)

Versions:
silver grey

Art. No.:
157394

Recommended bulb:
24W, 3000K, 1700lm
548024

(PU see page 617)

ONIO T5 TWIST Design by CDC

230~



Socket/Bulb:
G5/T5 EnergySaver (excl.)
24W

Material:
Aluminium

Dimensions:
W/H/D: 71,7/4,5/15 cm

Accessory/Included parts:
Electronic ballast (incl.)

Versions:
silver grey

Art. No.:
157544

Recommended bulb:
24W, 3000K, 1700lm
548024

(PU see page 617)

ONIO R7s Design by CDC

230~



Socket/Bulb:
R7s/R7s, 78 mm (excl.)
60W max.

Material:
Aluminium

Dimensions:
W/H/D: 30/4,5/13,5 cm

Versions:
silver grey

Art. No.:
157404

Recommended bulb:
48W EnergySaver ± 60W
2700K, 750lm, EEK=C
519206





TIDUR WALL profile lamp

230~

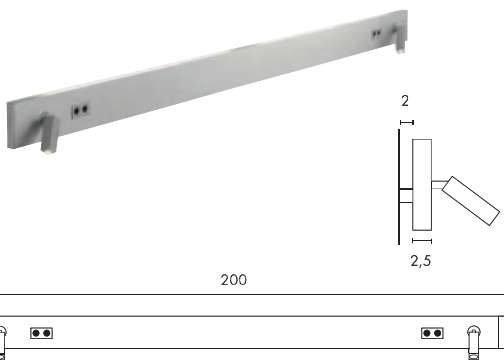
Socket/Bulb:
G5/T5 EnergySaver (excl.)
2x 21W
and
PowerLED (incl.)
2x 3W

Material:
Aluminium

Dimensions:
W/H/D: 200/12/16,2 cm

Accessory/Included parts:
Electronic ballast (incl.)
LED converter (incl.)
Switch (incl.)

Note:
Wall illumination and LED spots can
be switched separately.

Versions:	Art. No.:
alu brushed	146284
LED white	146282
LED warm white	

Recommended bulb:
21W, 3000K, 1910lm
548021

(PU see page 617)



TIDUR WALL SINGLE profile lamp

230~

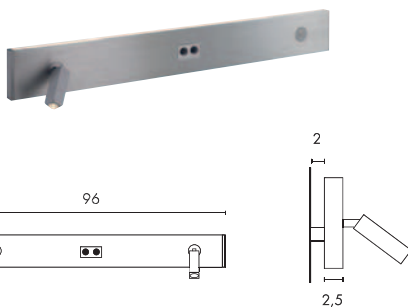
Socket/Bulb:
G5/T5 EnergySaver (excl.)
21W
and
PowerLED (incl.)
3W

Material:
Aluminium

Dimensions:
W/H/D: 96/12/16,2 cm

Accessory/Included parts:
Electronic ballast (incl.)
LED converter (incl.)
Switch (incl.)

Note:
Wall illumination and LED spot can
be switched separately.
The Spot can be mounted on the right
or left side.

Versions:	Art. No.:
alu brushed	146231
LED white	146232
LED warm white	

Recommended bulb:
21W, 3000K, 1910lm
548021

(PU see page 617)

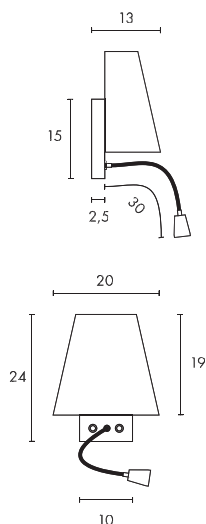

COUPA FLEXLED

Socket/Bulb:
 G9/G9 (excl.)
 40W max.
 or
 G9/EnergySaver (excl.)
 up to max. L: 9 cm
 and
 PowerLED (incl.)
 1W

Material:
 Steel/glass

Accessory/Included parts:
 LED converter (incl.)
 Switch (incl.)

Note:
 light sources can be switched separately.

Versions:
 chrome/white
 LED warm white

Art. No.:
 149452

Recommended bulb:
 9W, 2700K, 405lm, EEC=A
 508940





SWORD WL 160

230~

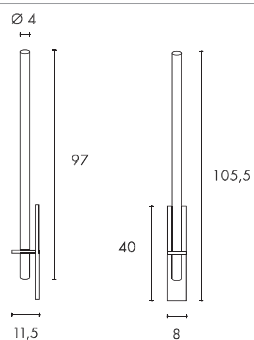

Socket/Bulb:
G5/T5 EnergySaver (excl.)
21W

Material:
Aluminium

Accessory/Included parts:
Electronic ballast (incl.)

Versions:
alu brushed

Art. No.:
149466

Recommended bulb:
21W, 3000K, 1910lm
548021

(PU see page 617)





CREST WL-1 Design by CDC

230~



Series: page 068



Socket/Bulb:
G5/T5 EnergySaver (excl.)
2x 24W

Material:
Zinc, chrome-plated/PP

Dimensions:
W/H/D: 13,5/75/9 cm

Accessory/Included parts:
Electronic ballast (incl.)

Versions:
chrome/white

Art. No.:
133782

Recommended bulb:
24W, 3000K, 1700lm
548024

(PU see page 617)



ONIO HIT-TC TWIST Design by CDC

230~

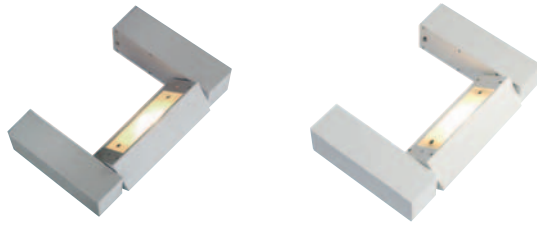

Socket/Bulb:
GU6,5/HIT-TC (excl.)
20W

Versions:
white
silver grey

Art. No.:
157551
157554

Material:
Aluminium

Dimensions:
W/H/D: 24,3/4,1/15,2 cm

Recommended bulb:
20W, 3000K, 1615lm
507020



Accessory/Included parts:
Electronic ballast (incl.)

SHELL WL-1 TC-DE Design by CDC

230~



Socket/Bulb:
G24q-3/
TC-DE EnergySaver (excl.)
26W

Versions:
white
silver grey

Art. No.:
150471
150474

Material:
Aluminium

Dimensions:
W/H/D: 22/15/16,5 cm

Recommended bulb:
26W, 3000K, 1800lm, EEK=B
508222



Accessory/Included parts:
Electronic ballast (incl.)

SHELL WL-2 Rx7s Design by CDC

230~



**HiEFFICIENT
PROFIlight.**

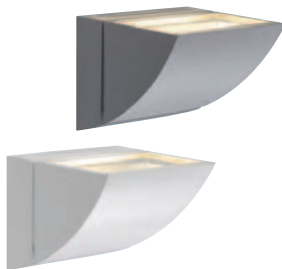

Socket/Bulb:
Rx7s/HQI-TS; CDM-TS (excl.)
70/150W

Versions:
70W
white
silver grey

Art. No.:
150481
150484

Versions:
150W
white
silver grey

Art. No.:
150491
150494

Material:
Aluminium

Dimensions:
W/H/D: 22/15/16,5 cm

Recommended bulb:
70W, 4200K, 6500lm
509071



Recommended bulb:
150W, 4200K, 12500lm
509151



Accessory/Included parts:
Electronic ballast (incl.)

Note:
Can only be used as uplight!

SHELL HQI-TS Design by CDC

230~



**HiEFFICIENT
PROFIlight.**



Socket/Bulb:
Rx7s/HQI-TS; CDM-TS (excl.)
70/150W

Versions:
70W
white
silver grey

Art. No.:
150331
150332

Versions:
150W
white
silver grey

Art. No.:
150631
150632

Material:
Steel

Dimensions:
W/H/D: 22,5/6/22,5 cm

Recommended bulb:
70W, 4200K, 6500lm
509071



Recommended bulb:
150W, 4200K, 12500lm
509151



Accessory/Included parts:
Electronic ballast (incl.)

Note:
Can only be used as uplight!



Series: page 161



Series: page 161

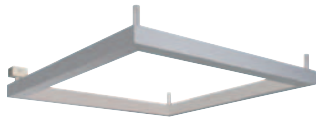

Art. No.: 157092

Design by CDC

T5 GRILL UNI

Accessory/Included parts:
Electronic ballast (incl.)

Dimensions:
Wall distance: 1,6 cm

Recommended bulb:
24W, 3000K, 1700lm
548024

(PU see page 617)



Art. No.: 157384

Design by CDC

OPEN GRILL Wall/Ceiling

Accessory/Included parts:
Electronic ballast (incl.)

Dimensions:
Profile: 4,5/4,5 cm
Canopy-L/W/H: 5/4,5/3 cm

Note:
Canopy at one corner.

Recommended bulb:
24W, 3000K, 1700lm
548024

(PU see page 617)



Art. No.: 157371

NEOPAN

Accessory/Included parts:
Electronic ballast (incl.)

Recommended bulb:
40W, 3000K, 3200lm, EEK=B
548210



Art. No.: 151656

NEODISC

Accessory/Included parts:
Low-loss ballast (incl.)

Note:
Chrome glass fastening.

Recommended bulb:
32W, 3000K, 2375lm, EEK=B
548230

**T5 GRILL UNI, OPEN GRILL, NEOPAN, NEODISC**

230~



Article No.	Description	Colour	Material	Voltage	Socket/ Bulb (excl.)	Wattage bulb	Energy efficiency category ballast	Length in cm	Width in cm	Height in cm	Weight
157092	T5 Grill Uni	silver grey satined acrylic glass	Aluminium/acrylic	230V AC	G5/T5 EnergySaver	4x 24W	EEL=A2	60,5	60,5	6,5	6,30 kg
157384	Open Grill wall/ceiling	silver grey	Aluminium	230V AC	G5/T5 EnergySaver	4x 24W	EEL=A2	68,0	68,0	10,0	3,05 kg
157371	Neopan	white	PMMA	230V AC	G10q/ T8-Ring EnergySaver	40W	EEL=A2	55,0	55,0	6,5	2,70 kg
151656	Neodisc	alu brushed/chrome Glass satined	Aluminium/glass	230V AC	G10q/ T8-Ring EnergySaver	32W	EEL=B2	40,0	40,0	6,5	3,60 kg





LED PANEL CL 136



Socket/Bulb:
SMD LED
50W

Material:
Aluminium/acrylic

Dimensions:
L/W/H: 59,6/59,6/3,2 cm

Accessory/Included parts:
Power unit (excl.)
4 spacer L: 5 cm (incl.)

Note:
For grid ceilings 60 x 60 cm.

Versions:
silver anodized
LED white
LED warm white

Art. No.:
158501
158502

For fitting into 62 x 62 cm
grid ceilings you need the
Grid lamp adapter

158110

Connection recommendation:

Power unit 60W, 24V=
470506



When connecting several lamps,
please pay attention to the total
wattage. Further power units can be
found from page 594 onward in the
accessory range.

KUNO CEILING

230~



Socket/Bulb:
G5/T5 EnergySaver (excl.)
2x 54W

Material:
Aluminium/Diffuser made of PMMA

Dimensions:
L/W/H: 119/13,5/3 cm

Accessory/Included parts:
Electronic ballast (incl.)

Versions:
silver grey

Art. No.:
160774

Recommended bulb:
54W, 3000K, 5000lm
548054

(PU see page 617)





CL 124 T5

230~



Series: page 051

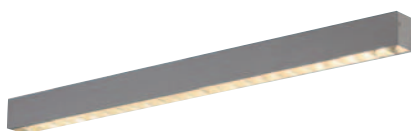

Socket/Bulb:
G5/T5 EnergySaver (excl.)
54W

Material:
Aluminium

Dimensions:
L/W/H: 120/7/8 cm

Versions:
silver grey

Art. No.:
158334

Recommended bulb:
54W, 3000K, 5000lm
548054

(PU see page 617)

Dark-light grid with DIN 5035-7 standard for display working stations.





LONG GRILL CEILING

230~



Series: page 049

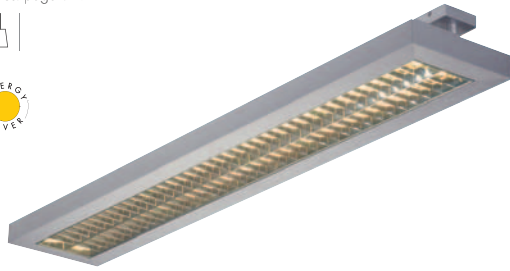

Ceiling lamp with Dark-Light grid, suitable for display working stations.

Socket/Bulb:
G5/T5 EnergySaver (excl.)
2x 54W

Material:
Aluminium

Dimensions:
L/W/H: 126/23/10,5 cm
Canopy-L/W/H: 7,5/7,5/2,5 cm

Accessory/Included parts:
Electronic ballast (incl.)
Canopy (incl.)

Versions:
silver grey

Art. No.:
157534

Recommended bulb:
54W, 3000K, 5000lm
548054

(PU see page 617)



Tristan T8 lamps are equipped with a chromed grid and high-polish reflector for a downwards emitted, glare-free light.

TRISTAN T8 18W

230~



Socket/Bulb:
G13/T8 EnergySaver (excl.)
2x 18W

Material:
Steel

Dimensions:
L/W/H: 70,5/18,5/6 cm

Accessory/Included parts:
Low-loss ballast (incl.)

Versions:
white

Art. No.:
160841

Recommended bulb:
18W, 3000K, 1350lm
548202

(PU see page 617)



TRISTAN T8 36W

230~



Socket/Bulb:
G13/T8 EnergySaver (excl.)
2x 36W

Material:
Steel

Dimensions:
L/W/H: 131,5/18,5/6 cm

Accessory/Included parts:
Low-loss ballast (incl.)

Versions:
white
silver grey

Art. No.:
160761
160764

TRISTAN T8 58W

230~



Socket/Bulb:
G13/T8 EnergySaver (excl.)
2x 58W

Material:
Steel

Dimensions:
L/W/H: 161/18,5/6 cm

Accessory/Included parts:
Low-loss ballast (incl.)

Versions:
white
silver grey

Art. No.:
160861
160864



TC GRID 218



230~



Socket/Bulb:
2G11/TC-L EnergySaver (excl.)
2x 18W

Versions:
white

Art. No.:
160771

Material:
Steel/aluminium grid

Recommended bulb:
18W, 2700K, 1200lm, EEK=A
508460



Dimensions:
L/W/H: 30,5/30,5/7 cm

Accessory/Included parts:
Low-loss ballast (incl.)

TC GRID 336



230~



Socket/Bulb:
2G11/TC-L EnergySaver (excl.)
3x 36W

Versions:
white

Art. No.:
160781

Material:
Steel/aluminium grid

Recommended bulb:
36W, 2700K, 2900lm, EEK=A
590144



Dimensions:
L/W/H: 50/50/7 cm

Accessory/Included parts:
Low-loss ballast (incl.)

The lamps TC Grid 218 and 336 are equipped with a high-polish reflector for a downwards emitted, glare-free light.



TC INDI 255

230~



Socket/Bulb:
2G11/TC-L EnergySaver (excl.)
2x 55W

Material:
Steel

Dimensions:
L/W/H: 58,5/55/6,5 cm

Accessory/Included parts:
Electronic ballast (incl.)

Note:
Indirect light emission.

Versions:
white

Art. No.:
160791

Recommended bulb:
55W, 2700K, 4800lm, EEK=A
508450





GLASSA TC-DE

230~

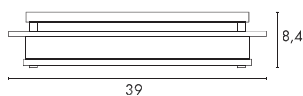

Socket/Bulb:
G24q-3/
TC-DE EnergySaver (excl.)
2x 26W

Material:
Steel/glass

Dimensions:
L/W/H: 39/39/8,4 cm

Accessory/Included parts:
Electronic ballast (incl.)

Versions:
Glass satined

Art. No.:
155190

Recommended bulb:
26W, 3000K, 1800lm, EEK=B
508222



GLASSA ROUND TC-DE

230~



Socket/Bulb:
G24q-3/
TC-DE EnergySaver (excl.)
2x 26W

Material:
Steel/glass

Dimensions:
Ø/H: 40/8,5 cm

Accessory/Included parts:
Electronic ballast (incl.)

Versions:
Glass satined

Art. No.:
155195

Recommended bulb:
26W, 3000K, 1800lm, EEK=B
508222



CL 133 T5 R

230~



Socket/Bulb:
2GX13/
T5-Ring EnergySaver (excl.)
40W

Material:
Steel/plastic

Dimensions:
Ø/H: 40,5/8 cm

Accessory/Included parts:
Electronic ballast (incl.)

Versions:
white

Art. No.:
133771

Recommended bulb:
40W, 3000K, 3400lm, EEK=A
548240



CL 134 TC-L

230~



Socket/Bulb:
2G11/TC-L EnergySaver (excl.)
2x 18W

Material:
Steel/plastic

Dimensions:
L/W/H: 30/30/6 cm

Accessory/Included parts:
Electronic ballast (incl.)

Versions:
white

Art. No.:
133772

Recommended bulb:
18W, 2700K, 1200lm, EEK=A
508460



LIPSY® OUT CEILING

230~



Socket/Bulb:
E27/ELD EnergySaver (excl.)
up to max. L: 16,5 cm
23W max.

Material:
Acrylic/steel

Dimensions:
Ø/H: 34/20,5 cm

Note:
To avoid a heat accumulation, no
incandescent bulbs may be used.

Versions:
white

Art. No.:
227351

Recommended bulb:
23W, 2700K, 1350lm, EEK=A
508970





LIPSY® Design by CDC

230~



Series: page 085

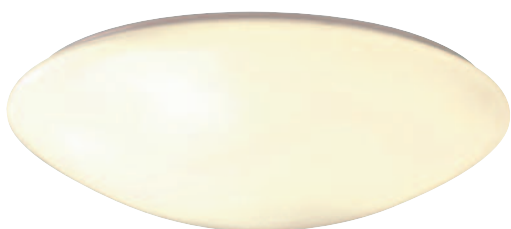

Two T8 ring tubes for a homogeneous light effect.

Socket/Bulb:
G10q/
T8-Ring EnergySaver (excl.)
1x 32W
1x 40W

Material:
Steel
Shade PMMA

Dimensions:
Ø/H: 55/14,5 cm

Accessory/Included parts:
Electronic ballast (incl.)

Versions:
white

Art. No.:
133723

Recommended bulb:
32W, 3000K, 2375lm, EEL=B
548230



Recommended bulb:
40W, 3000K, 3200lm, EEL=B
548210





SAINT 22 Design by CDC

230~



Socket/Bulb:
2GX13/
T5-Ring EnergySaver (excl.)
22W

Material:
Aluminium/glass

Dimensions:
Ø/D: 32/8,5 cm
Glass-Ø/D: 32/0,4 cm
Canopy-Ø/D: 10/7 cm

Accessory/Included parts:
Electronic ballast (incl.)

Versions:
alu brushed
Glass satined
Glass smoky grey

Art. No.:
149401
149402

Recommended bulb:
22W, 3000K, 1900lm, EEK=A
548220



AENEA WALL Design by CDC

230~



Socket/Bulb:
G10q/
T8-Ring EnergySaver (excl.)
40W

Material:
PC/steel

Dimensions:
Ø/H: 43/9 cm

Accessory/Included parts:
Electronic ballast (incl.)

Versions:
white/chrome

Art. No.:
149180

Recommended bulb:
40W, 3000K, 3200lm, EEK=B
548210









CL 101 GX53

230~

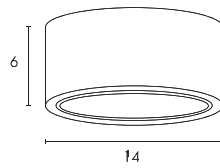

Socket/Bulb:
GX53/GX53 EnergySaver (excl.)
11W max.

Material:
Plastic

Versions:
white
silver grey

Art. No.:
112281
112284

Recommended bulb:
9W, 2700K, 260lm
508860



BANGIS

230~



Socket/Bulb:
E27/EnergySaver (excl.)
up to max. Ø/L: 4,5/13,5 cm
2x 11W max.

Material:
Steel/glass

Dimensions:
Ø/H: 2,5,5/6,5 cm

Versions:
white
chrome
silver grey

Art. No.:
161451
161452
161454

Recommended bulb:
11W, 2700K, 530lm, EEK=A
508950



TUBE Design by CDC

230~



Socket/Bulb:
G24d-3/
TC-D EnergySaver (excl.)
2x 26W

Material:
Steel/glass

Dimensions:
Ø/H: 2,5/14 cm

Accessory/Included parts:
Low-loss ballast (incl.)

Versions:
Glass satined
white/chrome

Art. No.:
161441

Recommended bulb:
26W, 2700K, 1800lm, EEK=B
508226



PL SURFACE MOUNTED CEILING LUMINAIRE 2x 26W

230~



Socket/Bulb:
G24d-3/
TC-D EnergySaver (excl.)
2x 26W

Material:
Aluminium/glass

Dimensions:
Ø/H: 2,3,5/15,5 cm

Accessory/Included parts:
Low-loss ballast (incl.)

Versions:
Glass satined
white
silver grey

Art. No.:
161431
161434

Recommended bulb:
26W, 2700K, 1800lm, EEK=B
508226





TROMP CL-1

230~



Socket/Bulb:
E27/EnergySaver (excl.)
up to max. Ø: 5,2 cm
4x 23W max.

Material:
Aluminium/acrylic

Dimensions:
Ø/H: 45/11 cm

Note:
Not suitable for incandescent bulbs.

Versions:
alu brushed

Art. No.:
133620

Recommended bulb:
21W, 2500K, 1230lm, EEK=A
508416



CL 135 T5 R

230~

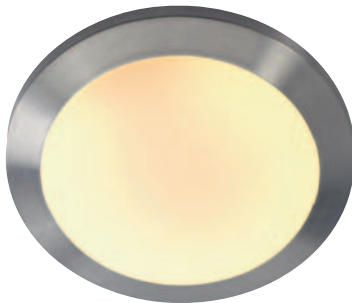

Socket/Bulb:
2GX13/
T5-Ring EnergySaver (excl.)
40W

Material:
Aluminium/steel/plastic

Dimensions:
Ø/H: 45/10,5 cm

Accessory/Included parts:
Electronic ballast (incl.)

Versions:
alu/white

Art. No.:
133760

Recommended bulb:
40W, 3000K, 3400lm, EEK=A
548240



MEDO

230~



Series: page 083



Socket/Bulb:
2GX13/
T5-Ring EnergySaver (excl.)
40W

Material:
Aluminium/glass

Dimensions:
Ø/H: 38/9,5 cm

Accessory/Included parts:
Electronic ballast (incl.)

Versions:
Glass satined
alu natural

Art. No.:
149252

Recommended bulb:
40W, 3000K, 3400lm, EEK=A
548240



MEDO PRO 60

230~



Socket/Bulb:
2G11/TC-L EnergySaver (excl.)
24W
and
G5/T5 EnergySaver (excl.)
24W

Material:
Aluminium/acrylic

Dimensions:
Product-Ø/H: 60/11,5 cm

Accessory/Included parts:
Electronic ballast (incl.)

Recommended bulb:
24W, 2700K, 1800lm, EEK=A
508440



Versions:
alu brushed/glass satined
white
silver grey

Art. No.:
133801
133804

Can be modified with the suspension
set into a pendant luminaire
(see page 084).

white
silver grey

133811
133814

Recommended bulb:
24W, 3000K, 1700lm
548024



[PU see page 617]

